

## European Technical Approval ETA-10/0005

English translation prepared by DIBt - Original version in German language

Handelsbezeichnung <i>Trade name</i>	Hilti Betonschraube HUS <i>Hilti Concrete screw HUS</i>
Zulassungsinhaber <i>Holder of approval</i>	Hilti Aktiengesellschaft Business Unit Anchors 9494 Schaan FÜRSTENTUM LIECHTENSTEIN
Zulassungsgegenstand und Verwendungszweck  <i>Generic type and use of construction product</i>	Betonschraube in der Größe 6 zur Verwendung als Mehrfachbefestigung für nichttragende Systeme in Beton und in Spannbeton-Hohlplattendecken  <i>Concrete screw size 6 for multiple use for non-structural applications in concrete and in prestressed hollow core slabs</i>
Geltungsdauer: <i>Validity:</i>	vom <i>from</i> bis <i>to</i>
Herstellwerk <i>Manufacturing plant</i>	Hilti Werke
	23 August 2011 23 April 2015

Diese Zulassung umfasst  
*This Approval contains*

21 Seiten einschließlich 13 Anhänge  
*21 pages including 13 annexes*

Diese Zulassung ersetzt  
*This Approval replaces*

ETA-10/0005 mit Geltungsdauer vom 12.05.2011 bis 23.04.2015  
*ETA-10/0005 with validity from 12.05.2011 to 23.04.2015*

## I LEGAL BASES AND GENERAL CONDITIONS

- 1 This European technical approval is issued by Deutsches Institut für Bautechnik in accordance with:
  - Council Directive 89/106/EEC of 21 December 1988 on the approximation of laws, regulations and administrative provisions of Member States relating to construction products<sup>1</sup>, modified by Council Directive 93/68/EEC<sup>2</sup> and Regulation (EC) N° 1882/2003 of the European Parliament and of the Council<sup>3</sup>;
  - Gesetz über das In-Verkehr-Bringen von und den freien Warenverkehr mit Bauprodukten zur Umsetzung der Richtlinie 89/106/EWG des Rates vom 21. Dezember 1988 zur Angleichung der Rechts- und Verwaltungsvorschriften der Mitgliedstaaten über Bauprodukte und anderer Rechtsakte der Europäischen Gemeinschaften (Bauproduktengesetz - BauPG) vom 28. April 1998<sup>4</sup>, as amended by law of 31 October 2006<sup>5</sup>;
  - Common Procedural Rules for Requesting, Preparing and the Granting of European technical approvals set out in the Annex to Commission Decision 94/23/EC<sup>6</sup>;
  - Guideline for European technical approval of "Metal anchors for use in concrete - Part 6: Anchors for multiple use for non-structural applications", ETAG 001-06.
- 2 Deutsches Institut für Bautechnik is authorized to check whether the provisions of this European technical approval are met. Checking may take place in the manufacturing plant. Nevertheless, the responsibility for the conformity of the products to the European technical approval and for their fitness for the intended use remains with the holder of the European technical approval.
- 3 This European technical approval is not to be transferred to manufacturers or agents of manufacturers other than those indicated on page 1, or manufacturing plants other than those indicated on page 1 of this European technical approval.
- 4 This European technical approval may be withdrawn by Deutsches Institut für Bautechnik, in particular pursuant to information by the Commission according to Article 5(1) of Council Directive 89/106/EEC.
- 5 Reproduction of this European technical approval including transmission by electronic means shall be in full. However, partial reproduction can be made with the written consent of Deutsches Institut für Bautechnik. In this case partial reproduction has to be designated as such. Texts and drawings of advertising brochures shall not contradict or misuse the European technical approval.
- 6 The European technical approval is issued by the approval body in its official language. This version corresponds fully to the version circulated within EOTA. Translations into other languages have to be designated as such.

<sup>1</sup> Official Journal of the European Communities L 40, 11 February 1989, p. 12  
<sup>2</sup> Official Journal of the European Communities L 220, 30 August 1993, p. 1  
<sup>3</sup> Official Journal of the European Union L 284, 31 October 2003, p. 25  
<sup>4</sup> *Bundesgesetzblatt Teil I 1998*, p. 812  
<sup>5</sup> *Bundesgesetzblatt Teil I 2006*, p. 2407, 2416  
<sup>6</sup> Official Journal of the European Communities L 17, 20 January 1994, p. 34

## II SPECIFIC CONDITIONS OF THE EUROPEAN TECHNICAL APPROVAL

### 1 Definition of product and intended use

#### 1.1 Definition of the construction product

The Hilti concrete screw HUS is an anchor made of galvanised steel (HUS-H, HUS-P, HUS-I, HUS-A) or stainless steel (HUS-HR) of size 6. The anchor is screwed into a predrilled cylindrical drill hole. The special thread of the anchor cuts an internal thread into the member while setting. The anchorage is characterised by mechanical interlock in the special thread.

An illustration of the product and intended use is given in Annexes 1 and 2.

#### 1.2 Intended use

The anchor is intended to be used for anchorages for which requirements for safety in use in the sense of the Essential Requirements 4 of Council Directive 89/106 EEC shall be fulfilled and failure of the fixture represents an immediate risk to human life. The anchor is to be used only for multiple use for non-structural applications. The definition of multiple use according to the Member States is given in the informative Annex 1 of ETAG 001, Part 6.

The anchor may be used for anchorages with requirements related to resistance to fire.

The anchor is to be used only for anchorages subject to static or quasi-static loading in reinforced or unreinforced normal weight concrete of strength classes C20/25 at minimum and C50/60 at most according to EN 206-1:2000-12.

It may be anchored for multiple use for non-structural applications in cracked or non-cracked concrete and in bottom flanges of precast pre-stressed hollow core slabs according to Annex 2.

##### Concrete Screw HUS-H, HUS-P, HUS-I, HUS-A:

The anchor made of galvanised steel may only be used in structures subject to dry internal conditions.

##### Concrete Screw Anchor HUS-HR:

The anchor made of stainless steel may be used in structures subject to dry internal conditions and also in structures subject to external atmospheric exposure (including industrial and marine environment), or exposure in permanently damp internal conditions, if no particular aggressive conditions exist. Such particular aggressive conditions are e. g. permanent, alternating immersion in seawater or the splash zone of seawater, chloride atmosphere of indoor swimming pools or atmosphere with extreme chemical pollution (e. g. in desulphurization plants or road tunnels where de-icing materials are used).

The provisions made in this European technical approval are based on an assumed working life of the anchor of 50 years. The indications given on the working life cannot be interpreted as a guarantee given by the producer, but are to be regarded only as a means for choosing the right products in relation to the expected economically reasonable working life of the works.

## 2 Characteristics of product and methods of verification

### 2.1 Characteristics of product

The anchor corresponds to the drawings and provisions given in Annex 3. The characteristic material values, dimensions and tolerances of the anchor not given in Annex 3 shall correspond to the respective values laid down in the technical documentation<sup>7</sup> of this European technical approval.

Regarding the requirements concerning safety in case of fire it is assumed that the anchor meets the requirements of class A1 in relation to reaction to fire in accordance with the stipulations of the Commission decision 96/603/EC, amended by 2000/605/EC.

The characteristic values for the design of anchorages are given in Annex 7, Table 7 for use in concrete C20/25 to C50/60 and in Annex 10, Table 8 for use in precast pre-stressed hollow core slabs.

The characteristic anchor values for the design of the anchorages regarding resistance to fire are given in Annex 10, Table 9. They are valid for use in a system that is required to provide a specific fire resistance class.

Each anchor is marked with the identifying mark of the producer including the anchor type, the anchor size and the length of screw according to Annex 1.

The anchor shall only be packaged and supplied as a complete unit.

### 2.2 Methods of verification

The assessment of the anchor for the intended use in relation to the requirements for safety in use in the sense of the Essential Requirements 4 has been made in accordance with the "Guideline for European technical approval of Metal Anchors for use in concrete", Part 1 "Anchors in general" and Part 6 "Anchors for multiple use for non-structural applications".

The assessment of the anchor for the intended use in relation to the requirements for resistance to fire has been made in accordance with the Technical Report TR 020 "Evaluation of anchorages in concrete concerning resistance to fire".

In addition to the specific clauses relating to dangerous substances contained in this European technical approval, there may be other requirements applicable to the products falling within its scope (e.g. transposed European legislation and national laws, regulations and administrative provisions). In order to meet the provisions of the Construction Products Directive, these requirements need also to be complied with, when and where they apply.

<sup>7</sup> The technical documentation of this European technical approval is deposited at the Deutsches Institut für Bautechnik and, as far as relevant for the tasks of the approved bodies involved in the attestation of conformity procedure, is handed over to the approved bodies.

### 3 Evaluation and attestation of conformity and CE marking

#### 3.1 System of attestation of conformity

According to the decision 97/161/EG of the European Commission<sup>8</sup> the system 2(ii) (referred to as system 2+) of attestation of conformity applies.

This system of attestation of conformity is defined as follows:

System 2+: Declaration of conformity of the product by the manufacturer on the basis of:

- (a) Tasks for the manufacturer:
  - (1) initial type-testing of the product;
  - (2) factory production control;
  - (3) testing of samples taken at the factory in accordance with a prescribed test plan.
- (b) Tasks for the approved body:
  - (4) certification of factory production control on the basis of:
    - initial inspection of factory and of factory production control;
    - continuous surveillance, assessment and approval of factory production control.

Note: Approved bodies are also referred to as "notified bodies".

#### 3.2 Responsibilities

##### 3.2.1 Tasks of the manufacturer

###### 3.2.1.1 Factory production control

The manufacturer shall exercise permanent internal control of production. All the elements, requirements and provisions adopted by the manufacturer shall be documented in a systematic manner in the form of written policies and procedures, including records of results performed. This production control system shall insure that the product is in conformity with this European technical approval.

The manufacturer may only use initial / raw / constituent materials stated in the technical documentation of this European technical approval.

The factory production control shall be in accordance with the control plan which is part of the technical documentation of this European technical approval. The control plan is laid down in the context of the factory production control system operated by the manufacturer and deposited at Deutsches Institut für Bautechnik.<sup>9</sup>

The results of factory production control shall be recorded and evaluated in accordance with the provisions of the control plan.

###### 3.2.1.2 Other tasks of manufacturer

The manufacturer shall, on the basis of a contract, involve a body which is approved for the tasks referred to in section 3.1 in the field of the anchor in order to undertake the actions laid down in section 3.3. For this purpose, the control plan referred to in sections 3.2.1.1 and 3.2.2 shall be handed over by the manufacturer to the approved body involved.

The manufacturer shall make a declaration of conformity, stating that the construction product is in conformity with the provisions of this European technical approval.

<sup>8</sup> Official Journal of the European Communities L 67 of 03.02.1997

<sup>9</sup> The control plan is a confidential part of the European Technical Approval and only handed over to the approved body involved in the procedure of attestation of conformity. See section 3.2.2.

### 3.2.2 Tasks of approved bodies

The approved body shall perform the

- initial inspection of factory and of factory production control,
- continuous surveillance, assessment and approval of factory production control.

in accordance with the provisions laid down in the control plan relating to this European technical approval.

The approved body shall retain the essential points of its actions referred to above and state the results obtained and conclusions drawn in a written report.

The approved certification body involved by the manufacturer shall issue an EC certificate of conformity of the factory production control stating the conformity with the provisions of this European technical approval.

In cases where the provisions of the European technical approval and its control plan are no longer fulfilled the certification body shall withdraw the certificate of conformity and inform Deutsches Institut für Bautechnik without delay.

### 3.3 CE marking

The CE marking shall be affixed on each packing of the anchor. The letters "CE" shall be followed by the identification number of the approved certification body, where relevant, and be accompanied by the following additional information:

- the name and address of the producer (legal entity responsible for the manufacture),
- the last two digits of the year in which the CE marking was affixed,
- the number of the EC certificate for the factory production,
- the number of the European technical approval,
- the number of the guideline for European technical approval,
- use category (ETAG 001-6),
- size.

## 4 Assumptions under which the fitness of the product for the intended use was favourably assessed

### 4.1 Manufacturing

The European technical approval is issued for the product on the basis of agreed data/information, deposited with Deutsches Institut für Bautechnik, which identifies the product that has been assessed and judged. Changes to the product or production process, which could result in this deposited data/information being incorrect, should be notified to Deutsches Institut für Bautechnik before the changes are introduced. Deutsches Institut für Bautechnik will decide whether or not such changes affect the European technical approval and consequently the validity of the CE marking on the basis of the European technical approval and if so whether further assessment or alterations to the European technical approval shall be necessary.

#### 4.2 Design of anchorages

The fitness of the anchor for the intended use is given under the following conditions:

The anchorages are designed in accordance with the "Guideline for European technical approval of Metal Anchors for Use in Concrete", Annex C, Method B under the responsibility of an engineer experienced in anchorages and concrete work.

The anchor is to be used only for multiple use for non-structural applications, the definition of multiple use according to the Member States is given in the informative Annex 1 of ETAG 001, Part 6.

Verifiable calculation notes and drawings are prepared taking account of the loads to be anchored.

The position of the anchor is indicated on the design drawings (e.g. position of the anchor relative to reinforcement or to supports).

The shear load of anchor groups in one fastening point is limited to  $\max. V = 25 \text{ kN}$ .

The design of anchorages under fire exposure has to consider the conditions given in the Technical Report TR 020 "Evaluation of anchorages in concrete concerning resistance to fire". The relevant characteristic values are given in Annex 10, Table 9. The design method covers anchors with a fire attack from one side only. If the fire attack is from more than one side, the design method may be taken only, if the edge distance of the anchor is  $c \geq 300 \text{ mm}$ .

Local spalling is possible at fire attack. To avoid any influence of the spalling on the anchorage, the concrete member must be designed according to EN 1992-1-2:2004. The members shall be made of concrete with quartzite additives and have to be protected from direct moisture; and the moisture content of the concrete has to be like in dry internal conditions respectively. The anchorage depth has to be increased for wet concrete by at least 30 mm compared to the given value in the approval.

#### 4.3 Installation of anchors

The fitness for use of the anchor can only be assumed if the anchor is installed as follows:

- Anchor installation carried out by appropriately qualified personnel under the supervision of the person responsible for technical matters on site,
- Use of the anchor only as supplied by the manufacturer,
- Anchor installation in accordance with the manufacturer's specifications and drawings,
- Checks before placing the anchor, to ensure that the characteristic values of the base material in which the anchor is to be placed, is identical with the values, which the characteristic loads apply,
- Check of the concrete being well compacted, e.g. without significant voids,
- Edge distances and spacing not less than the specified values without minus tolerances,
- Placing drill holes without damaging the reinforcement,
- In case of aborted hole: new drilling at a minimum distance away of twice the depth of the aborted hole or smaller distance if the aborted hole is filled with high strength mortar and if under shear or oblique tension load it is not the direction of the load application,

- Cleaning of the hole of drilling dust in accordance with Annex 11 to 13,
- Anchor installation such that the embedment depth of the anchor in the concrete is not smaller than the value  $h_{nom}$  given in Annex 5, Table 4,
- Further turning of the anchor is not possible,
- The head of the anchor is fully supported on the fixture and is not damaged.

## 5 Responsibility of the manufacturer

The manufacturer is responsible to ensure that the information on the specific conditions according to sections 1 and 2 including Annexes referred to as well as sections 4.2 and 4.3 is given to those who are concerned. This information may be made by reproduction of the respective parts of the European technical approval. In addition all installation data shall be shown clearly on the package and/or on an enclosed instruction sheet, preferably using illustration(s).

The minimum data required are:

- drill bit diameter,
- thread diameter,
- minimum effective anchorage depth,
- minimum hole depth,
- maximum thickness of fixture,
- torque moment,
- information on the installation procedure, including cleaning of the hole, preferably by means of an illustration,
- reference to any special installation equipment needed,
- identification of the manufacturing batch.

All data shall be presented in a clear and explicit form.

Georg Feistel  
Head of Department

*beglaubigt:*  
Bürger



### Hilti Screw anchor

**HUS-HR 6**

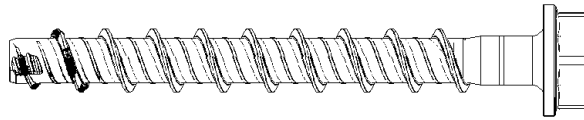

**HUS-H 6**

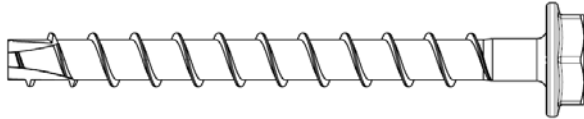

**HUS-P 6**

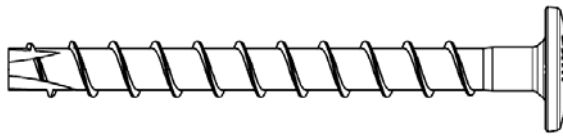

**HUS-I 6**

Internal threads  
M8 and M10

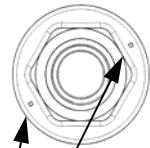
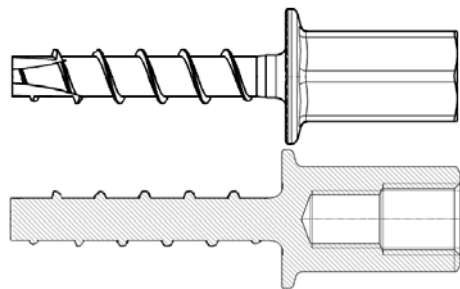

One circle mark  $d = 0,8 \text{ mm}$  for  $h_{\text{nom}} = 35 \text{ mm}$   
Two circle marks  $d = 0,8 \text{ mm}$  for  $h_{\text{nom}} = 55 \text{ mm}$

**HUS-A 6**

External thread  
M8 or M10

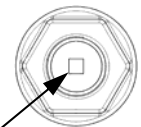
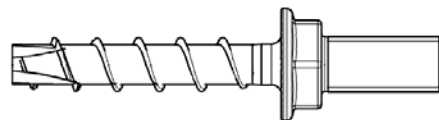

Quadratic marking  $2 \text{ mm} \times 2 \text{ mm}$  for  $h_{\text{nom}} = 35 \text{ mm}$   
Circle mark with  $d = 2,5 \text{ mm}$  for  $h_{\text{nom}} = 55 \text{ mm}$

**Hilti screw anchor HUS**

**Product**

**Annex 1**

of European  
technical approval  
**ETA-10/0005**

### Intended use in concrete

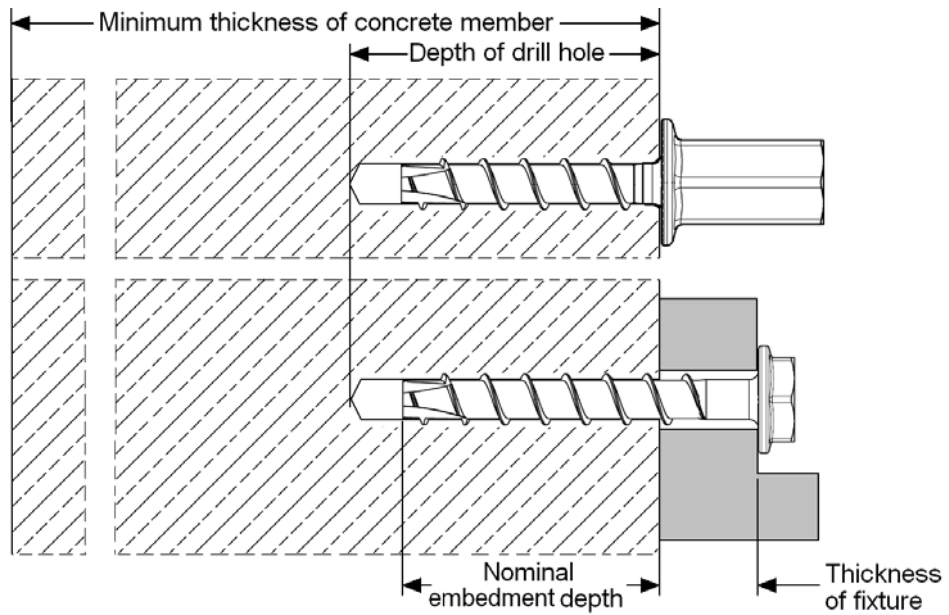

### Intended use in precast prestressed hollow core slabs ( $w/e \leq 4,2$ )

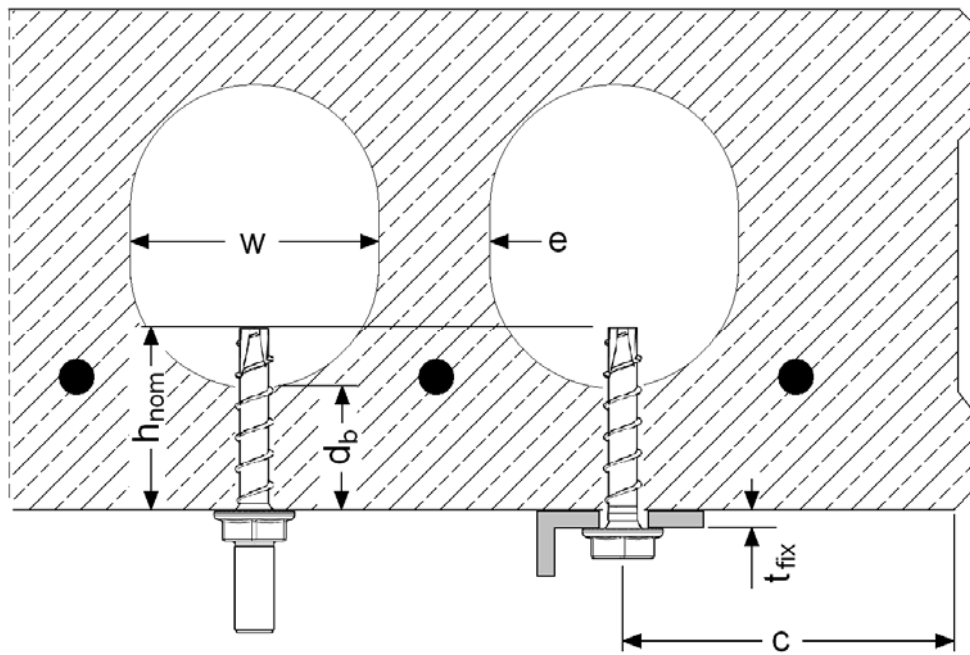

$w$  core width  
 $h_{nom}$  nominal embedment depth  
 $t_{fix}$  thickness of fixture

$e$  web thickness  
 $d_b$  bottom flange thickness  $\geq 25$  mm  
 $c$  edge distance

**Hilti screw anchor HUS**

**Intended use**

**Annex 2**

of European  
technical approval  
**ETA-10/0005**

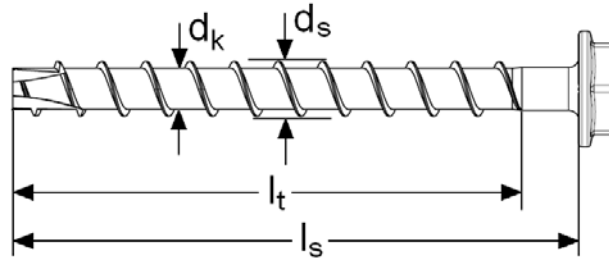

**Table 1: Materials**

Part	Designation	Material
Screw anchor	HUS-HR 6	Stainless Steel (A4 grade)
Screw anchor	HUS-H 6, HUS-P 6, HUS-I 6, HUS-A 6	Carbon Steel, galvanized ( $\geq 5 \mu\text{m}$ )

**Table 2: Dimensions**

Hilti screw anchor	HUS-HR 6x60	HUS-HR 6x70	HUS-H 6x40	HUS-H 6x60	HUS-H 6x80	HUS-H 6x100	HUS-H 6x120	HUS-P 6x40	HUS-P 6x60	HUS-P 6x80	HUS-I 6x35 M8/M10	HUS-I 6x55 M8/M10	HUS-A 6x35 M8	HUS-A 6x35 M10	HUS-A 6x55 M8	HUS-A 6x55 M10
Nominal length of screw $l_s$ [mm]	60	70	40	60	80	100	120	40	60	80	35	55	35	35	55	55
Thread length $l_t$ [mm]	55	55	37	55	72			37	55	72	32	52	32		52	
Outer diameter of thread $d_s$ [mm]	7,6		7,85													
Core diameter $d_k$ [mm]	5,4		5,85													

<b>Hilti screw anchor HUS</b>	<b>Annex 3</b> of European technical approval <b>ETA-10/0005</b>
<b>Materials and dimensions</b>	

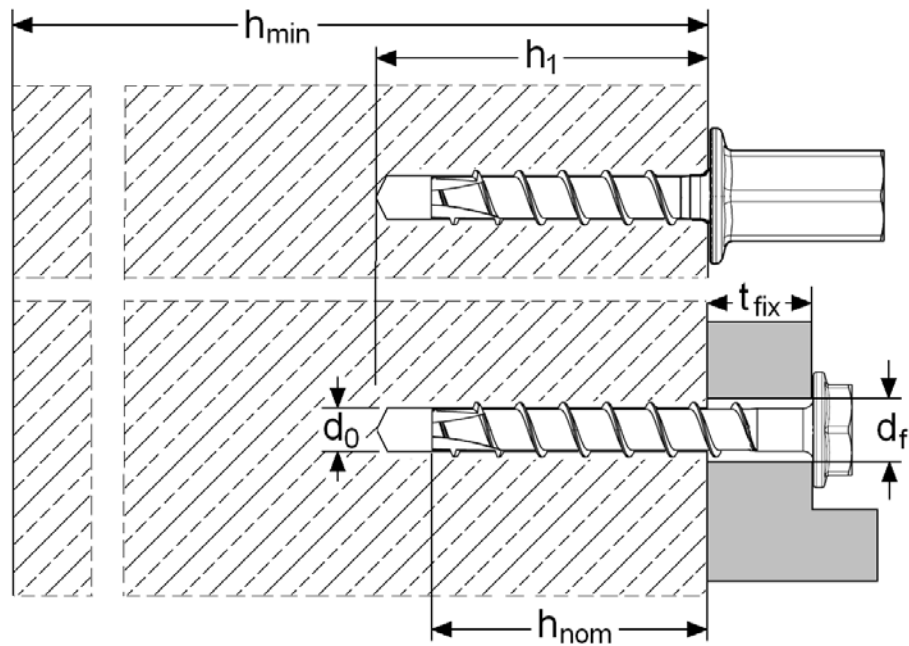

**Table 3:** General installation data

Hilti screw anchor HUS		-HR 6	-H 6	-P 6	-I 6	-A 6
Nominal anchorage depth	$h_{nom} \geq$ [mm]	35				
Nominal diameter of drill bit	$d_0$ [mm]	6				
Cutting diameter of drill bit	$d_{cut} \leq$ [mm]	6,40				
Clearance hole diameter	$d_f \leq$ [mm]	9				
Width across flats	SW [mm]	13	13	-	13	13
TORX		-	T30	T30	-	-

<b>Hilti screw anchor HUS</b>	<b>Annex 4</b> of European technical approval <b>ETA-10/0005</b>
<b>Installation data</b>	

**Table 4:** Installation data in concrete

Hilti screw anchor HUS		-HR 6	-H 6	-P 6	-I 6	-A 6
Nominal anchorage depth	$h_{nom} \geq$ [mm]	35				
Effective anchorage depth	$h_{ef}$ [mm]	27	25			
Depth of drill hole <sup>1)</sup>	$h_1 \geq$ [mm]	$h_{nom} + 10$ mm				
Thickness of fixture	$t_{fix} \leq$ [mm]	40	85	45	-	-

1) For overhead installation the required drill hole depth is given in Annex 12 and Annex 13.

**Table 5:** Installation data in precast prestressed hollow core slabs

Hilti screw anchor		HUS-H 6x40	HUS-H 6x60	HUS-H 6x80	HUS-H 6x100	HUS-H 6x120	HUS-P 6x40	HUS-P 6x60	HUS-P 6x80	HUS-I 6x35 M8/M10	HUS-I 6x55 M8/M10	HUS-A 6x35 M8	HUS-A 6x35 M10	HUS-A 6x55 M8	HUS-A 6x55 M10
Nominal length of screw	$l_s$ [mm]	40	60	80	100	120	40	60	80	35	55	35	35	55	55
Thickness of fixture	$t_{fix} \geq$ [mm]	0	2	5	25	45	0	2	5	-	-	-	-	-	-
	$t_{fix} \leq$ [mm]	5	25	45	65	85	5	25	45	-	-	-	-	-	-

**Hilti screw anchor HUS**

**Installation data**

**Annex 5**

of European  
technical approval  
**ETA-10/0005**

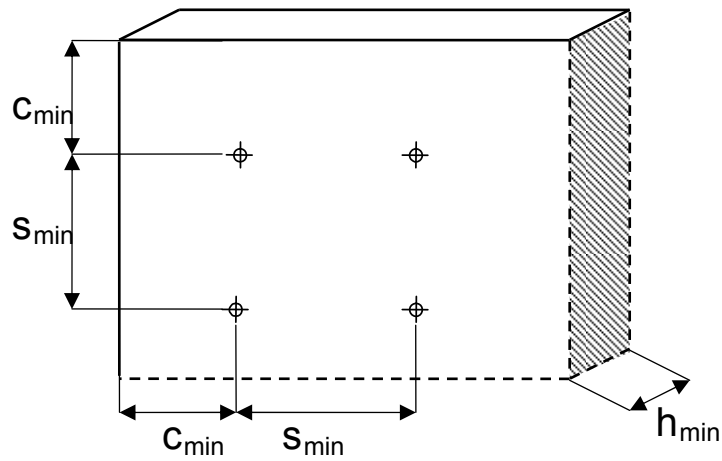

**Table 6:** Minimum thickness of concrete member, minimum spacing and minimum edge distances of anchors

Hilti screw anchor HUS		-HR 6	-H 6	-P 6	-I 6	-A 6
Nominal anchorage depth	$h_{nom} \geq$ [mm]	35				
Minimum member thickness	$h_{min}$ [mm]	80				
Minimum edge distance	$c_{min}$ [mm]	35 (80) <sup>1)</sup>				
Minimum spacing	$s_{min}$ [mm]	35				

<sup>1)</sup> see table 7, Annex 7

<b>Hilti screw anchor HUS</b>	<b>Annex 6</b> of European technical approval <b>ETA-10/0005</b>
<b>Minimum thickness of concrete, minimum spacing and edge distances of anchors</b>	

**Table 7:** Design method B – Characteristic values of resistance in concrete

Hilti screw anchor HUS				-HR 6	-H 6	-P 6	-I 6	-A 6
Nominal anchorage depth		$h_{nom} \geq$	[mm]	35				
All load directions								
Characteristic resistance in C20/25 for spacing	$c \geq 35\text{mm}$	$F_{Rk}^0$	[kN]	3	2			
	$c \geq 80\text{ mm}$	$F_{Rk}^0$	[kN]	5	3			
Partial safety factor		$\gamma_M$	<sup>1)</sup>	2,1	<sup>2)</sup> 1,5 <sup>3)</sup>			
Increasing factors for $F_{Rk}^0$		$\Psi_c$	C30/37	1,22				
			C40/50	1,41				
			C50/60	1,55				
Characteristic edge distance		$c_{cr}$	[mm]	1,5 $h_{ef}$				
Characteristic spacing		$s_{cr}$	[mm]	3 $h_{ef}$				
Shear load with lever arm								
Characteristic bending resistance		$M_{Rk,s}^0$	<sup>4)</sup> [Nm]	19	22			
Partial safety factor		$\gamma_{Ms}$	<sup>1)</sup>	1,5	1,5			

<sup>1)</sup> In absence of other national regulations.

<sup>2)</sup> The installation factor  $\gamma_2 = 1,4$  is included.

<sup>3)</sup> The installation factor  $\gamma_2 = 1,0$  is included.

<sup>4)</sup> Characteristic bending moment  $M_{Rk,s}^0$  for equation (5.5) in ETAG 001, Annex C.

**Hilti screw anchor HUS**

**Characteristic values of resistance according design method B**

**Annex 7**

of European technical approval  
**ETA-10/0005**

## Admissible anchor positions in precast prestressed hollow core slabs

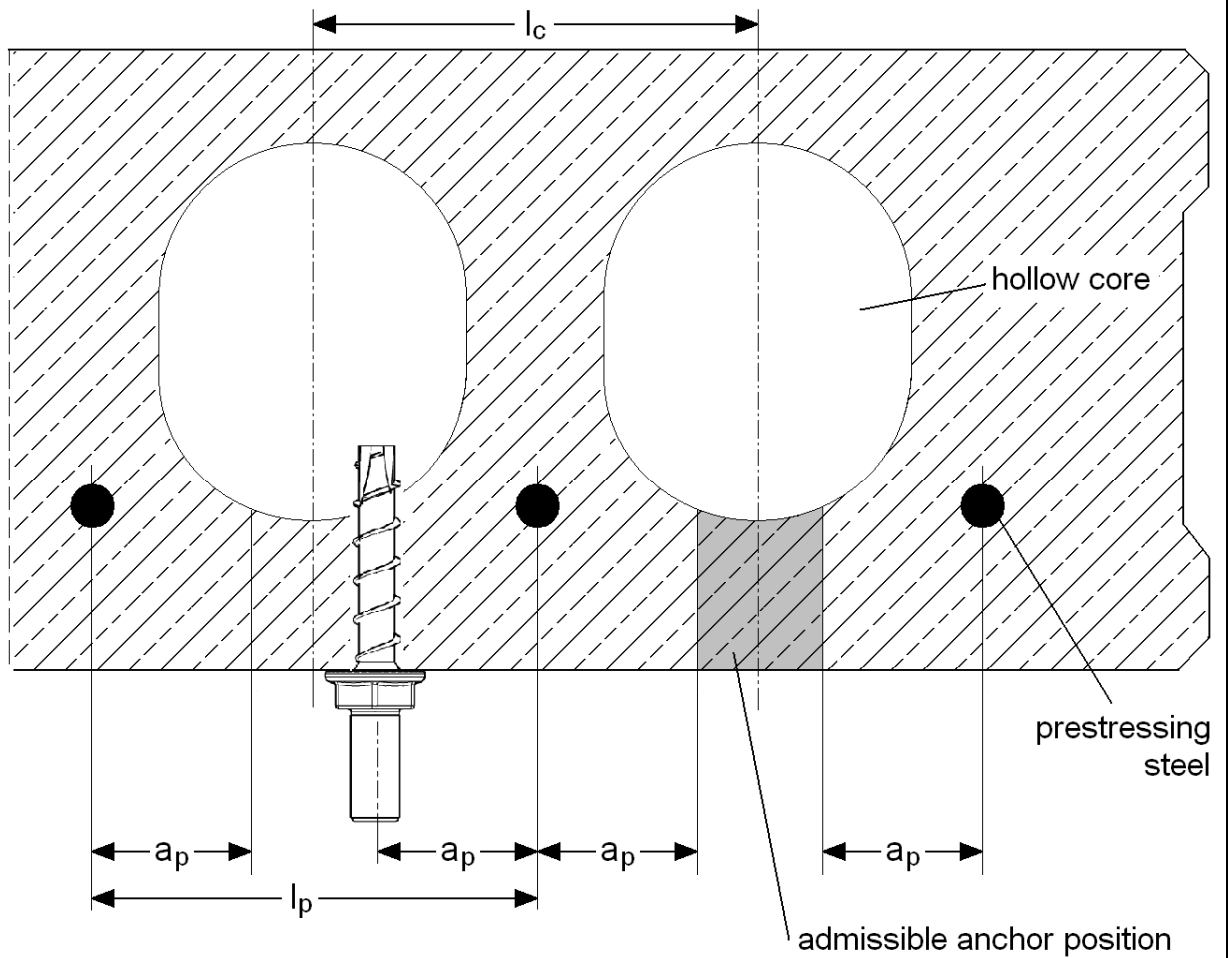

core distance	$l_c \geq 100 \text{ mm}$
prestressing steel distance	$l_p \geq 100 \text{ mm}$
distance between anchor position and prestressing steel	$a_p \geq 50 \text{ mm}$

**Hilti screw anchor HUS**

**Admissible anchor positions in precast prestressed hollow core slabs**

**Annex 8**

of European technical approval  
**ETA-10/0005**



## Minimum spacing and edge distance of anchors and distance between anchor groups in precast prestressed hollow core slabs

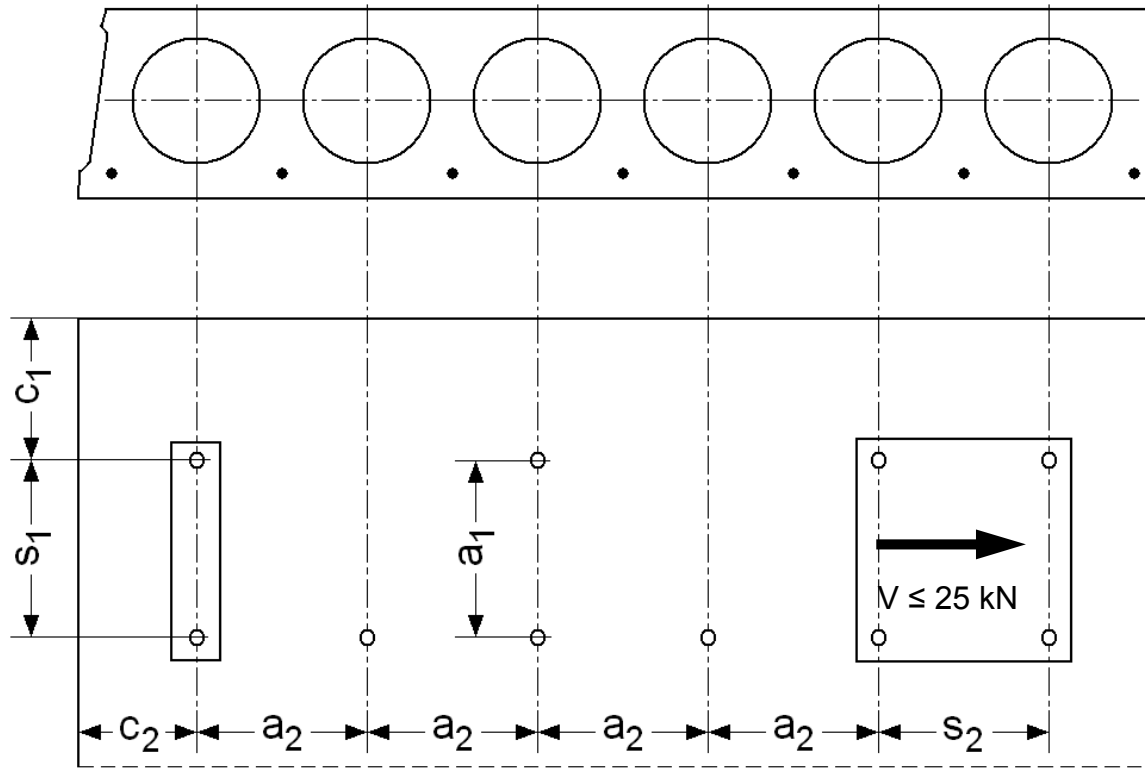

$c_1, c_2$  edge distances  
 $s_1, s_2$  anchor spacings  
 $a_1, a_2$  distances between anchor groups

Minimum edge distance  $c_{min} \geq 100 \text{ mm}$

Minimum anchor spacing  $s_{min} \geq 100 \text{ mm}$

Minimum distance between anchor groups  $a_{min} \geq 100 \text{ mm}$

The maximum shear load of an anchor group is restricted to max.  $V = 25 \text{ kN}$ .

**Hilti screw anchor HUS**

**Minimum spacing and edge distances of anchors and distance between anchor groups in precast prestressed hollow core slabs**

**Annex 9**

of European technical approval  
**ETA-10/0005**

**Table 8:** Characteristic values of resistance in precast prestressed hollow core slabs C30/37 to C50/60

<b>Hilti screw anchor HUS-H 6 / HUS-P 6 / HUS-I 6 / HUS-A 6</b>			
All load directions			
Bottom flange thickness	[mm]	≥ 25	≥ 30
Characteristic resistance	$F_{RK}^0$ [kN]	1	2
Partial safety factor	$\gamma_M$ <sup>1)</sup>	1,5 <sup>2)</sup>	

<sup>1)</sup> In absence of other national regulations.

<sup>2)</sup> The installation factor  $\gamma_2 = 1,0$  is included.

**Table 9:** Characteristic values of resistance in cracked and non-cracked concrete C20/25 to C50/60 under fire exposure

<b>Hilti screw anchor HUS</b>			<b>-HR 6</b>		<b>-H 6, -P 6, -I 6, -A 6</b>	
Nominal anchorage depth	$h_{nom} \geq$	[mm]	<b>35</b>	<b>55</b>	<b>35</b>	<b>55</b>
All load directions						
Characteristic resistance	R30...R90	$F_{RK,fi}$ [kN]	0,7	1,3	0,5	0,8
	R120	$F_{RK,fi}$ [kN]	0,5	1,0	0,4	0,6
Edge distance	R30...R120	$c_{cr}$ [mm]	54	90	50	84
Anchor spacing	R30...R120	$s_{cr}$ [mm]	108	180	100	168

In absence of other national regulations the partial safety factor for resistance under fire exposure  $\gamma_{M,fi} = 1,0$  is recommended.

The fire resistance data is only valid for concrete C20/25 to C50/60 with a minimum slab thickness of 80 mm. The data is not valid for precast prestressed hollow core slabs.

The edge distance of the anchor must be  $c \geq 300$  mm and  $\geq 2 h_{ef}$  if the fire attack is from more than one side.

The embedment depth has to be increased for wet concrete by at least 30 mm compared to the minimum embedment depth.

<b>Hilti screw anchor HUS</b>	<b>Annex 10</b> of European technical approval <b>ETA-10/0005</b>
<b>Characteristic values of resistance in precast prestressed hollow core slabs and characteristic values of resistance under fire exposure</b>	

## Setting instruction for HUS-HR 6 for applications in concrete

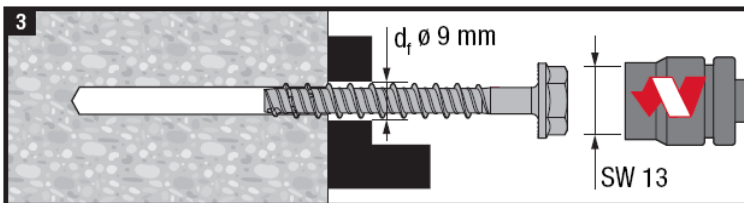
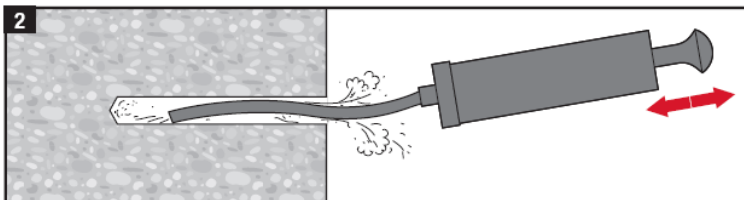
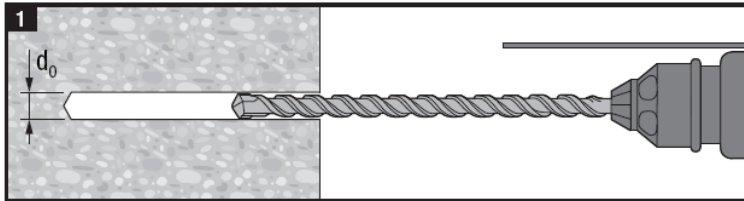
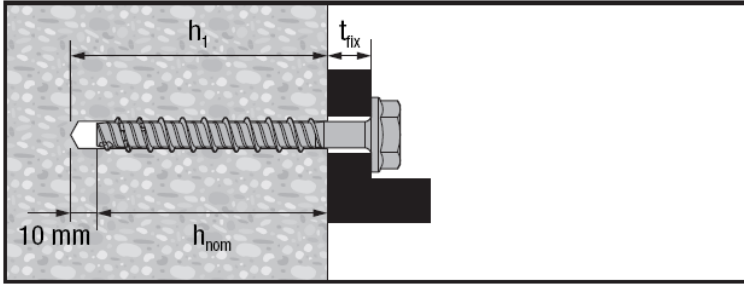

**3.1**

	$h_{nom}$ 30 mm	35 mm	55 mm
SIW/SID 121	✓	✓	✓
SIW/SID 144	✓	✓	✓
SIW 22T-A	✗	✗	✗
SI 100	✗	✗	✗
TKI 2500	✓	✓	✓
SIW 144	✗	✗	✗

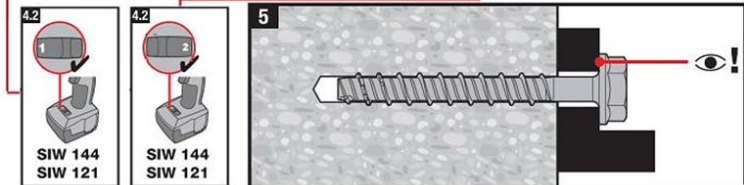

Hand setting of HUS-HR in concrete base material not allowed (machine setting only)

Hilti recommended electrical impact screw drivers are listed in the instruction for use included in the sales box.

Installation with other electrical impact screw drivers of equivalent force and performance is possible.

**Hilti screw anchor HUS**





**Setting instruction for HUS-HR 6 for applications in concrete**

**Annex 11**

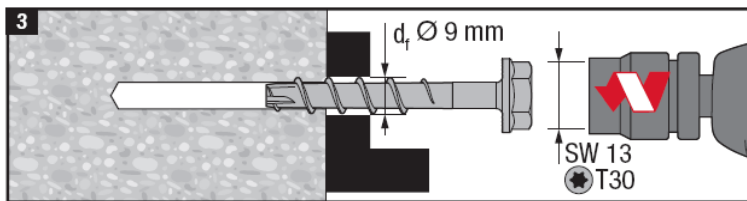
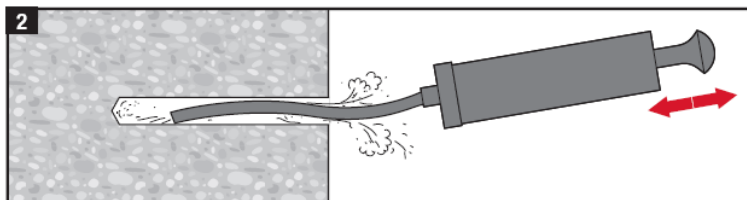
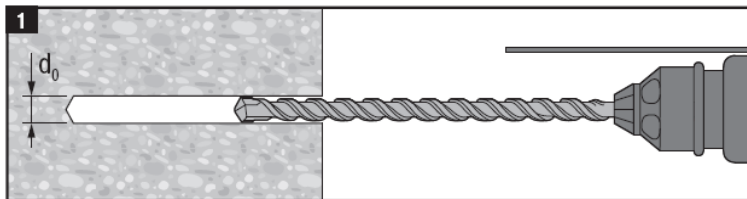
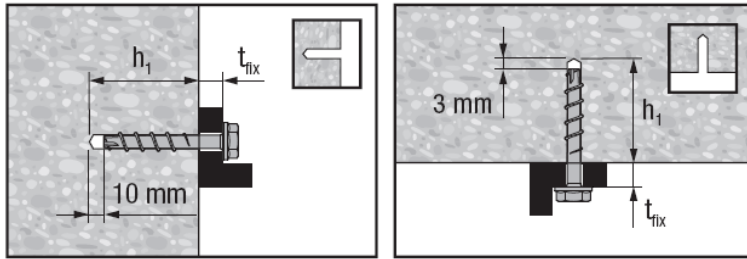
of European technical approval  
**ETA-10/0005**

## Setting instruction for HUS-H 6, HUS-P 6, HUS-A 6 and HUS-I 6 for applications in concrete



3.1	
 SIW/SID 121	✓
 SIW/SID 144	✓
 TKI 2500	✓
	18 Nm

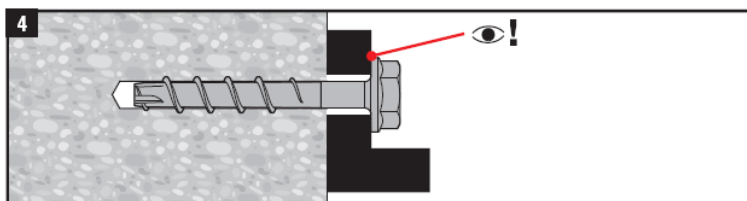

Installation with other electrical impact screw drivers of equivalent force and performance is possible.

Hilti recommended electrical impact screw drivers are listed in the instruction for use included in the sales box.

**Hilti screw anchor HUS**

**Setting instruction for HUS-H 6, HUS-P 6, HUS-A 6 and HUS-I 6 for applications in concrete**

**Annex 12**

of European technical approval  
**ETA-10/0005**

## Setting instruction for HUS-H 6, HUS-P 6, HUS-A 6 and HUS-I 6 for applications in precast prestressed hollow core slabs

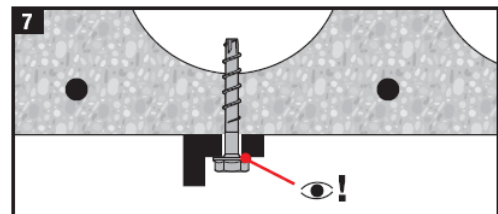
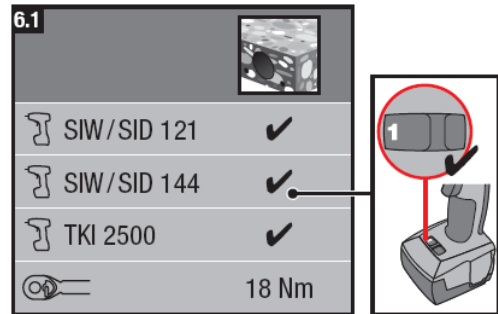
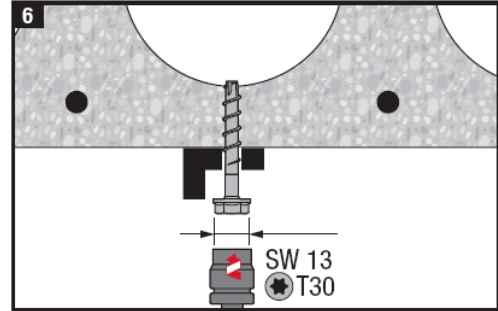
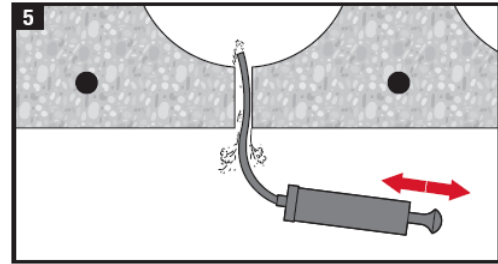
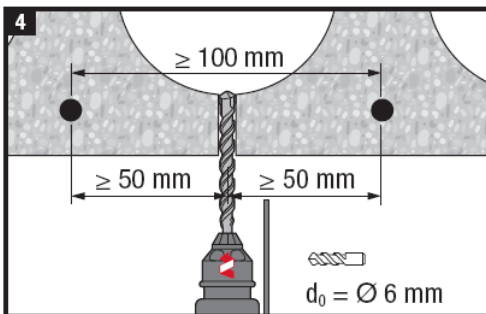
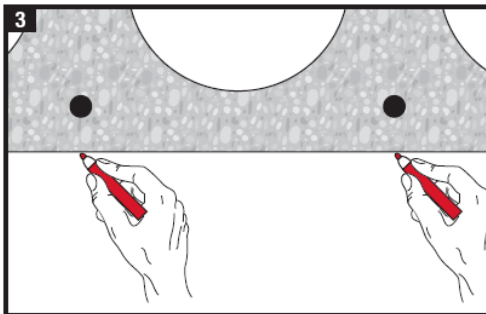
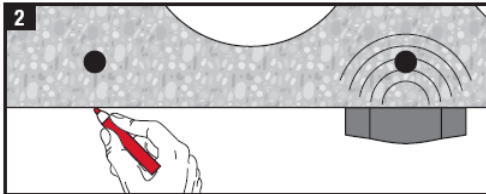
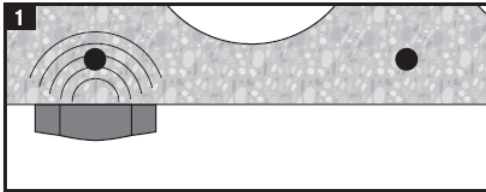
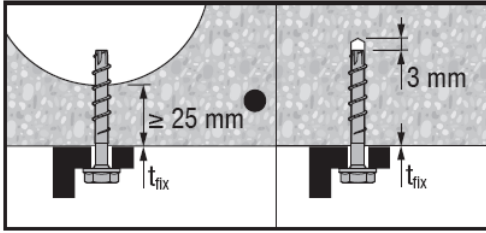

Installation with other electrical impact screw drivers of equivalent force and performance is possible. Hilti recommended electrical impact screw drivers are listed in the instruction for use included in the sales box.

### Hilti screw anchor HUS

Setting instruction for HUS-H 6, HUS-P 6, HUS-A 6 and HUS-I 6 for applications in precast prestressed hollow core slabs

### Annex 13

of European technical approval  
ETA-10/0005