

## HSL-3 carbon steel, heavy duty anchor

Anchor version		Benefits
	HSL-3 Bolt version	- suitable for non-cracked and cracked concrete C 20/25 to C 50/60
	HSL-3-G Threaded rod version	- high loading capacity - force-controlled expansion - reliable pull-down of the part fastened
	HSL-3-B Safety cap version	- no rotation in hole when tightening bolt
	HSL-3-SH Hexagonal socked head screws	
	HSL-3-SK Countersunk version	



Concrete



Tensile zone



Fire resistance



Fatigue



Shock



Seismic



European Technical Approval



CE conformity



PROFIS Anchor design software

### Approvals / certificates

Description	Authority / Laboratory	No. / date of issue
European technical approval <sup>a)</sup>	CSTB, Paris	ETA-02/0042 / 2008-01-10
ICC-ES report incl. seismic	ICC evaluation service	ESR 1545 / 2012-03-01
Shockproof fastenings in civil defence installations	Federal Office for Civil Protection, Bern	BZS D 08-601 / 2008-06-30
Fire test report	IBMB, Braunschweig	UB 3041/1663-CM / 2004-03-22
Assessment report (fire)	warringtonfire	WF 166402 / 2007-10-26

a) All data given in this section according ETA-02/0042, issue 2008-01-10.

### Basic loading data (for a single anchor)

All data in this section applies to

- Correct setting (See setting instruction)
- No edge distance and spacing influence
- Concrete as specified in the table
- Steel failure
- Minimum base material thickness
- Concrete C 20/25,  $f_{ck,cube} = 25 \text{ N/mm}^2$

For details see Simplified design method

**Mean ultimate resistance**

Anchor size	Non-cracked concrete						Cracked concrete					
	M8	M10	M12	M16	M20	M24	M8	M10	M12	M16	M20	M24
Tensile $N_{Ru,m}$ [kN]	31,1	39,2	47,9	66,9	93,5	122,9	15,9	21,2	34,2	47,8	66,8	87,8
Shear $V_{Ru,m}$												
HSL-3, HSL-3-B, HSL-3-SK <sup>a)</sup> , HSL-3-SH <sup>a)</sup> [kN]	43,0	68,0	95,8	133,8	187,0	245,3	40,0	56,0	68,4	95,6	133,6	175,6
HSL-3-G <sup>b)</sup> [kN]	36,1	48,1	75,1	118,5	187,0	-	36,1	48,1	68,4	95,6	133,6	-

**Characteristic resistance**

Anchor size	Non-cracked concrete						Cracked concrete					
	M8	M10	M12	M16	M20	M24	M8	M10	M12	M16	M20	M24
Tensile $N_{Rk}$ [kN]	23,4	29,5	36,1	50,4	70,4	92,6	12,0	16,0	25,8	36,0	50,3	66,1
Shear $V_{Rk}$												
HSL-3, HSL-3-B, HSL-3-SK <sup>a)</sup> , HSL-3-SH <sup>a)</sup> [kN]	31,1	49,2	71,7	100,8	140,9	177,4	30,1	42,2	51,5	72,0	100,6	132,3
HSL-3-G <sup>b)</sup> [kN]	26,1	34,8	54,3	85,7	140,9	-	26,1	34,8	51,5	72,0	100,6	-

**Design resistance**

Anchor size	Non-cracked concrete						Cracked concrete					
	M8	M10	M12	M16	M20	M24	M8	M10	M12	M16	M20	M24
Tensile $N_{Rd}$ [kN]	15,6	19,7	24,0	33,6	47,0	61,7	6,7	10,7	17,2	24,0	33,5	44,1
Shear $V_{Rd}$												
HSL-3, HSL-3-B, HSL-3-SK <sup>a)</sup> , HSL-3-SH <sup>a)</sup> [kN]	24,9	39,4	48,1	67,2	93,9	123,5	20,1	28,1	34,3	48,0	67,1	88,2
HSL-3-G <sup>b)</sup> [kN]	20,9	27,8	43,4	67,2	93,9	-	20,1	27,8	34,3	48,0	67,1	-

**Recommended loads**

Anchor size	Non-cracked concrete						Cracked concrete					
	M8	M10	M12	M16	M20	M24	M8	M10	M12	M16	M20	M24
Tensile $N_{rec}^{c)}$ [kN]	11,2	14,1	17,2	24,0	33,5	44,1	4,8	7,6	12,3	17,1	24,0	31,5
Shear $V_{rec}^{c)}$												
HSL-3, HSL-3-B, HSL-3-SK <sup>a)</sup> , HSL-3-SH <sup>a)</sup> [kN]	17,8	28,1	34,3	48,0	67,1	88,2	14,3	20,1	24,5	34,3	47,9	63,0
HSL-3-G <sup>b)</sup> [kN]	14,9	19,9	31,0	48,0	67,1	-	14,3	19,9	24,5	34,3	47,9	-

a) HSL-3-SK and HSL-3-SH is only available up to M12

b) HSL-3-G is only available up to M20

c) With overall partial safety factor for action  $\gamma = 1,4$ . The partial safety factors for action depend on the type of loading and shall be taken from national regulations.

## Materials

### Mechanical properties of HSL-3, HSL-3-G, HSL-3-B, HSL-3-SH, HSL-3-SK

Anchor size	M8	M10	M12	M16	M20	M24
Nominal tensile strength $f_{uk}$ [N/mm <sup>2</sup> ]	800	800	800	800	830	830
Yield strength $f_{yk}$ [N/mm <sup>2</sup> ]	640	640	640	640	640	640
Stressed cross-section $A_s$ [mm <sup>2</sup> ]	36,6	58,0	84,3	157	245	353
Moment of resistance $W$ [mm <sup>3</sup> ]	31,3	62,5	109,4	277,1	540,6	935,4
Design bending resistance without sleeve $M_{Rd,s}$ [Nm]	24,0	48,0	84,0	212,8	415,2	718,4

### Material quality

Part	Material
Bolt, threaded rod	steel strength 8.8, galvanised to min. 5 $\mu$ m

## Anchor dimensions

### Dimensions of HSL-3, HSL-3-G, HSL-3-B, HSL-3-SH, HSL-3-SK

Anchor version	Thread size	$t_{fix}$ [mm]		$d_s$ [mm]	$l_1$ [mm]	$l_2$ [mm]	$l_3$ [mm]	$l_4$ [mm]		$p$ [mm]
		min	max					min	max	
HSL-3	M8	5	200	11,9	12	32	15,2	19	214	2
HSL-3-G	M10	5	200	14,8	14	36	17,2	23	218	3
HSL-3	M12	5	200	17,6	17	40	20	28	223	3
HSL-3-G	M16	10	200	23,6	20	54,4	24,4	34,5	224,5	4
HSL-3-B	M20	10	200	27,6	20	57	31,5	51	241	4
HSL-3	M24	10	200	31,6	22	65	39	57	247	4
HSL-3-SH	M8	5		11,9	12	32	15,2	19		2
	M10	20		14,8	14	36	17,2	38		3
	M12	25		17,6	17	40	20	48		3
HSL-3-SK	M8	10	20	11,9	12	32	15,2	18,2	28,2	2
	M10	20		14,8	14	36	17,2	32,2		3
	M12	25		17,6	17	40	20	40		3

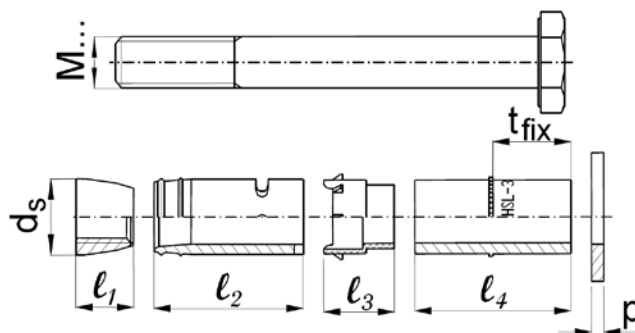

### Setting

#### installation equipment

Anchor size	M8	M10	M12	M16	M20	M24
Rotary hammer	TE2 – TE16			TE40 – TE70		
Other tools	hammer, torque wrench, blow out pump					

#### Setting instruction

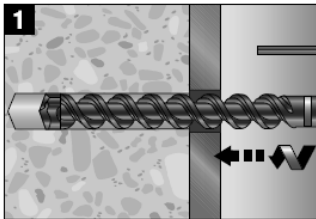

Drill hole.

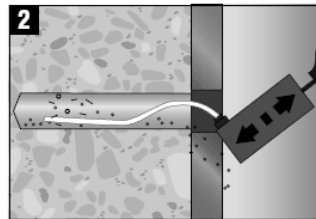

Blow out dust and fragments.

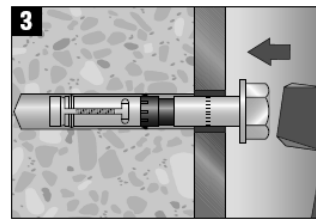

Install anchor.

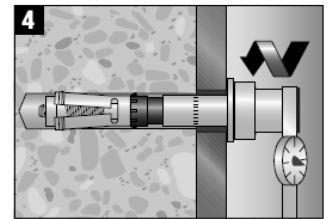

Apply tightening torque  
(for HSL-3-B: no torque wrench is needed)

For detailed information on installation see instruction for use given with the package of the product.

For technical data for anchors in diamond drilled holes please contact the Hilti Technical advisory service.

#### Setting details: depth of drill hole $h_1$ and effective anchorage depth $h_{ef}$

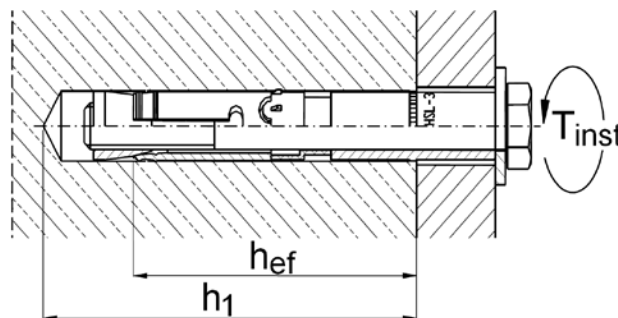

#### Setting details HSL-3

Anchor version HSL-3			M8	M10	M12	M16	M20	M24
Nominal diameter of drill bit	$d_o$	[mm]	12	15	18	24	28	32
Cutting diameter of drill bit	$d_{cut} \leq$	[mm]	12,5	15,5	18,5	24,55	28,55	32,7
Depth of drill hole	$h_1 \geq$	[mm]	80	90	105	125	155	180
Diameter of clearance hole in the fixture	$d_f \leq$	[mm]	14	17	20	26	31	35
Effective anchorage depth	$h_{ef}$	[mm]	60	70	80	100	125	150
Torque moment	$T_{inst}$	[Nm]	25	50	80	120	200	250
Width across	SW	[mm]	13	17	19	24	30	36

### Setting details HSL-3-G

Anchor version HSL-3-G							
			M8	M10	M12	M16	M20
Nominal diameter of drill bit	$d_o$	[mm]	12	15	18	24	28
Cutting diameter of drill bit	$d_{cut} \leq$	[mm]	12,5	15,5	18,5	24,55	28,55
Depth of drill hole	$h_1 \geq$	[mm]	80	90	105	125	155
Diameter of clearance hole in the fixture	$d_f \leq$	[mm]	14	17	20	26	31
Effective anchorage depth	$h_{ef}$	[mm]	60	70	80	100	125
Torque moment	$T_{inst}$	[Nm]	20	35	60	80	160
Width across	SW	[mm]	13	17	19	24	30

### Setting details HSL-3-B

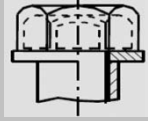
Anchor version HSL-3-B						
			M12	M16	M20	M24
Nominal diameter of drill bit	$d_o$	[mm]	18	24	28	32
Cutting diameter of drill bit	$d_{cut} \leq$	[mm]	18,5	24,55	28,55	32,7
Depth of drill hole	$h_1 \geq$	[mm]	105	125	155	180
Diameter of clearance hole in the fixture	$d_f \leq$	[mm]	20	26	31	35
Effective anchorage depth	$h_{ef}$	[mm]	80	100	125	150
Width across	SW	[mm]	24	30	36	41

The torque moment is controlled by the safety cap

### Setting details HSL-3-SH

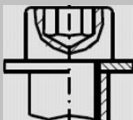
Anchor version HSL-3-SH					
			M8	M10	M12
Nominal diameter of drill bit	$d_o$	[mm]	12	15	18
Cutting diameter of drill bit	$d_{cut} \leq$	[mm]	12,5	15,5	18,5
Depth of drill hole	$h_1 \geq$	[mm]	85	95	110
Diameter of clearance hole in the fixture	$d_f \leq$	[mm]	14	17	20
Effective anchorage Depth	$h_{ef}$	[mm]	60	70	80
Torque moment	$T_{inst}$	[Nm]	25	35	60
Width across	SW	[mm]	6	8	10

### Setting details HSL-3-SK

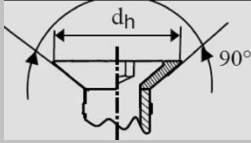
Anchor version HSL-3-SK				M8	M10	M12
						
Nominal diameter of drill bit	$d_o$	[mm]		12	15	18
Cutting diameter of drill bit	$d_{cut} \leq$	[mm]		12,5	15,5	18,5
Depth of drill hole	$h_1 \geq$	[mm]		80	90	105
Diameter of clearance hole in the fixture	$d_f \leq$	[mm]		14	17	20
Diameter of countersunk hole in the fixture	$d_h =$	[mm]		22,5	25,5	32,9
Effective anchorage Depth	$h_{ef}$	[mm]		60	70	80
Torque moment	$T_{inst}$	[Nm]		25	50	80
Size of hexagon socket screw key	SW	[mm]		5	6	8

### Setting parameters

Anchor size			M8	M10	M12	M16	M20	M24
Minimum base material thickness	$h_{min}$	[mm]	120	140	160	200	250	300
Minimum spacing	$s_{min}$	[mm]	60	70	80	100	125	150
	for $c \geq$	[mm]	100	100	160	240	300	300
Minimum edge distance	$c_{min}$	[mm]	60	70	80	100	150	150
	for $s \geq$	[mm]	100	160	240	240	300	300
Critical spacing for splitting failure	$s_{cr,sp}$	[mm]	230	270	300	380	480	570
Critical edge distance for splitting failure	$c_{cr,sp}$	[mm]	115	135	150	190	240	285
Critical spacing for concrete cone failure	$s_{cr,N}$	[mm]	180	210	240	300	375	450
Critical edge distance for concrete cone failure	$c_{cr,N}$	[mm]	90	105	120	150	187,5	225

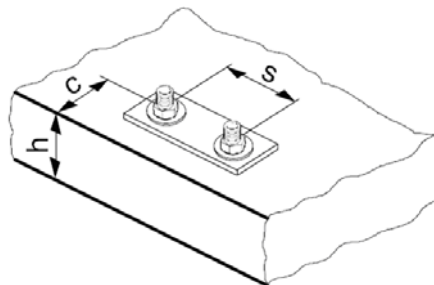

For spacing (edge distance) smaller than critical spacing (critical edge distance) the design loads have to be reduced.

Critical spacing and critical edge distance for splitting failure apply only for non-cracked concrete. For cracked concrete only the critical spacing and critical edge distance for concrete cone failure are decisive.

## Simplified design method

Simplified version of the design method according ETAG 001, Annex C. Design resistance according data given in ETA-02/0042, issue 2008-01-10.

- Influence of concrete strength
- Influence of edge distance
- Influence of spacing
- Valid for a group of two anchors. (The method may also be applied for anchor groups with more than two anchors or more than one edge. The influencing factors must then be considered for each edge distance and spacing. The calculated design loads are then on the same side: They will be lower than the exact values according ETAG 001, Annex C. To avoid this, it is recommended to use the anchor design software PROFIS anchor)

The design method is based on the following simplification:

- No different loads are acting on individual anchors (no eccentricity)

The values are valid for one anchor.

For more complex fastening applications please use the anchor design software PROFIS Anchor.

## Tension loading

### The design tensile resistance is the lower value of

- Steel resistance:  $N_{Rd,s}$
- Concrete pull-out resistance:  $N_{Rd,p} = N_{Rd,p}^0 \cdot f_B$
- Concrete cone resistance:  $N_{Rd,c} = N_{Rd,c}^0 \cdot f_B \cdot f_{1,N} \cdot f_{2,N} \cdot f_{3,N} \cdot f_{re,N}$
- Concrete splitting resistance (only non-cracked concrete):  
 $N_{Rd,sp} = N_{Rd,c}^0 \cdot f_B \cdot f_{1,sp} \cdot f_{2,sp} \cdot f_{3,sp} \cdot f_{h,sp} \cdot f_{re,N}$

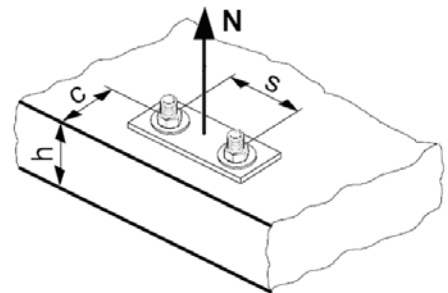

## Basic design tensile resistance

### Design steel resistance $N_{Rd,s}$

Anchor size		M8	M10	M12	M16	M20	M24
$N_{Rd,s}$	[kN]	19,5	30,9	44,9	83,7	130,7	188,3

### Design pull-out resistance $N_{Rd,p} = N_{Rd,p}^0 \cdot f_B$ (only M8, M10 in cracked concrete)

Anchor size		Non-cracked concrete						Cracked concrete							
		M8	M10	M12	M16	M20	M24	M8	M10	M12	M16	M20	M24		
$N_{Rd,p}^0$	[kN]	No pull-out failure						6,7	10,7	No pull-out failure					

### Design concrete cone resistance $N_{Rd,c} = N_{Rd,c}^0 \cdot f_B \cdot f_{1,N} \cdot f_{2,N} \cdot f_{3,N} \cdot f_{re,N}$

### Design splitting resistance <sup>a)</sup> $N_{Rd,sp} = N_{Rd,c}^0 \cdot f_B \cdot f_{1,sp} \cdot f_{2,sp} \cdot f_{3,sp} \cdot f_{h,sp} \cdot f_{re,N}$

Anchor size		Non-cracked concrete						Cracked concrete					
		M8	M10	M12	M16	M20	M24	M8	M10	M12	M16	M20	M24
$N_{Rd,c}^0$	[kN]	15,6	19,7	24,0	33,6	47,0	61,7	11,2	14,1	17,2	24,0	33,5	44,1

a) Splitting resistance must only be considered for non-cracked concrete

### Influencing factors

#### Influence of concrete strength

Concrete strength designation (ENV 206)	C 20/25	C 25/30	C 30/37	C 35/45	C 40/50	C 45/55	C 50/60
$f_B = (f_{ck,cube}/25N/mm^2)^{1/2}$ a)	1	1,1	1,22	1,34	1,41	1,48	1,55

a)  $f_{ck,cube}$  = concrete compressive strength, measured on cubes with 150 mm side length

#### Influence of edge distance a)

$c/c_{cr,N}$	0,1	0,2	0,3	0,4	0,5	0,6	0,7	0,8	0,9	1
$c/c_{cr,sp}$										
$f_{1,N} = 0,7 + 0,3 \cdot c/c_{cr,N} \leq 1$	0,73	0,76	0,79	0,82	0,85	0,88	0,91	0,94	0,97	1
$f_{1,sp} = 0,7 + 0,3 \cdot c/c_{cr,sp} \leq 1$										
$f_{2,N} = 0,5 \cdot (1 + c/c_{cr,N}) \leq 1$	0,55	0,60	0,65	0,70	0,75	0,80	0,85	0,90	0,95	1
$f_{2,sp} = 0,5 \cdot (1 + c/c_{cr,sp}) \leq 1$										

a) The edge distance shall not be smaller than the minimum edge distance  $c_{min}$  given in the table with the setting details. These influencing factors must be considered for every edge distance.

#### Influence of anchor spacing a)

$s/s_{cr,N}$	0,1	0,2	0,3	0,4	0,5	0,6	0,7	0,8	0,9	1
$s/s_{cr,sp}$										
$f_{3,N} = 0,5 \cdot (1 + s/s_{cr,N}) \leq 1$	0,55	0,60	0,65	0,70	0,75	0,80	0,85	0,90	0,95	1
$f_{3,sp} = 0,5 \cdot (1 + s/s_{cr,sp}) \leq 1$										

a) The anchor spacing shall not be smaller than the minimum anchor spacing  $s_{min}$  given in the table with the setting details. This influencing factor must be considered for every anchor spacing.

#### Influence of base material thickness

$h/h_{ef}$	2,0	2,2	2,4	2,6	2,8	3,0	3,2	3,4	3,6	$\geq 3,68$
$f_{h,sp} = [h/(2 \cdot h_{ef})]^{2/3}$	1	1,07	1,13	1,19	1,25	1,31	1,37	1,42	1,48	1,5

#### Influence of reinforcement

Anchor size	M8	M10	M12	M16	M20	M24
$f_{re,N} = 0,5 + h_{ef}/200mm \leq 1$	0,8 a)	0,85 a)	0,9 a)	1	1	1

a) This factor applies only for dense reinforcement. If in the area of anchorage there is reinforcement with a spacing  $\geq 150$  mm (any diameter) or with a diameter  $\leq 10$  mm and a spacing  $\geq 100$  mm, then a factor  $f_{re,N} = 1$  may be applied.

### Shear loading

#### The design shear resistance is the lower value of

- Steel resistance:  $V_{Rd,s}$
- Concrete pryout resistance:  $V_{Rd,cp} = k \cdot N_{Rd,c}$
- Concrete edge resistance:  $V_{Rd,c} = V_{Rd,c}^0 \cdot f_B \cdot f_{\beta} \cdot f_h \cdot f_4 \cdot f_{hef} \cdot f_c$

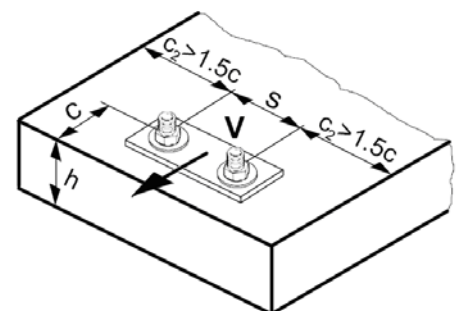



## Basic design shear resistance

### Design steel resistance $V_{Rd,s}$

Anchor size		M8	M10	M12	M16	M20	M24
$V_{Rd,s}$	HSL-3, HSL-3-B, HSL-3-SK <sup>a)</sup> , HSL-3-SH <sup>a)</sup> [kN]	24,9	39,4	57,4	80,9	113,5	141,9
	HSL-3-G [kN]	20,9	27,8	43,4	68,6	113,5	-

a) HSL-3-SK and HSL-3-SH is only available up to M12

### Design concrete pryout resistance $V_{Rd,cp} = k \cdot N_{Rd,c}$ <sup>a)</sup>

Anchor size	M8	M10	M12	M16	M20	M24
k	1,8			2,0		

a)  $N_{Rd,c}$ : Design concrete cone resistance

### Design concrete edge resistance<sup>a)</sup> $V_{Rd,c} = V_{Rd,c}^0 \cdot f_B \cdot f_\beta \cdot f_h \cdot f_4 \cdot f_{hef} \cdot f_c$

Anchor size	Non-cracked concrete						Cracked concrete					
	M8	M10	M12	M16	M20	M24	M8	M10	M12	M16	M20	M24
$V_{Rd,c}^0$ [kN]	11,7	16,9	22,9	36,8	47,7	59,7	8,3	12,0	16,2	26,1	33,8	42,3

a) For anchor groups only the anchors close to the edge must be considered.

## Influencing factors

### Influence of concrete strength

Concrete strength designation (ENV 206)	C 20/25	C 25/30	C 30/37	C 35/45	C 40/50	C 45/55	C 50/60
$f_B = (f_{ck,cube}/25N/mm^2)^{1/2}$ <sup>a)</sup>	1	1,1	1,22	1,34	1,41	1,48	1,55

a)  $f_{ck,cube}$  = concrete compressive strength, measured on cubes with 150 mm side length

### Influence of angle between load applied and the direction perpendicular to the free edge

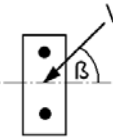
Angle $\beta$	0°	10°	20°	30°	40°	50°	60°	70°	80°	≥ 90°
$f_\beta = \sqrt{\frac{1}{(\cos \alpha_v)^2 + \left(\frac{\sin \alpha_v}{2,5}\right)^2}}$ 	1	1,01	1,05	1,13	1,24	1,40	1,64	1,97	2,32	2,50

### Influence of base material thickness

h/c	0,15	0,3	0,45	0,6	0,75	0,9	1,05	1,2	1,35	≥ 1,5
$f_h = \{h/(1,5 \cdot c)\}^{1/2} \leq 1$	0,32	0,45	0,55	0,63	0,71	0,77	0,84	0,89	0,95	1,00

**Influence of anchor spacing and edge distance <sup>a)</sup> for concrete edge resistance:  $f_4$** 

$$f_4 = (c/h_{ef})^{1,5} \cdot (1 + s / [3 \cdot c]) \cdot 0,5$$

c/h <sub>ef</sub>	Single anchor	Group of two anchors s/h <sub>ef</sub>														
		0,75	1,50	2,25	3,00	3,75	4,50	5,25	6,00	6,75	7,50	8,25	9,00	9,75	10,50	11,25
0,50	0,35	0,27	0,35	0,35	0,35	0,35	0,35	0,35	0,35	0,35	0,35	0,35	0,35	0,35	0,35	0,35
0,75	0,65	0,43	0,54	0,65	0,65	0,65	0,65	0,65	0,65	0,65	0,65	0,65	0,65	0,65	0,65	0,65
1,00	1,00	0,63	0,75	0,88	1,00	1,00	1,00	1,00	1,00	1,00	1,00	1,00	1,00	1,00	1,00	1,00
1,25	1,40	0,84	0,98	1,12	1,26	1,40	1,40	1,40	1,40	1,40	1,40	1,40	1,40	1,40	1,40	1,40
1,50	1,84	1,07	1,22	1,38	1,53	1,68	1,84	1,84	1,84	1,84	1,84	1,84	1,84	1,84	1,84	1,84
1,75	2,32	1,32	1,49	1,65	1,82	1,98	2,15	2,32	2,32	2,32	2,32	2,32	2,32	2,32	2,32	2,32
2,00	2,83	1,59	1,77	1,94	2,12	2,30	2,47	2,65	2,83	2,83	2,83	2,83	2,83	2,83	2,83	2,83
2,25	3,38	1,88	2,06	2,25	2,44	2,63	2,81	3,00	3,19	3,38	3,38	3,38	3,38	3,38	3,38	3,38
2,50	3,95	2,17	2,37	2,57	2,77	2,96	3,16	3,36	3,56	3,76	3,95	3,95	3,95	3,95	3,95	3,95
2,75	4,56	2,49	2,69	2,90	3,11	3,32	3,52	3,73	3,94	4,15	4,35	4,56	4,56	4,56	4,56	4,56
3,00	5,20	2,81	3,03	3,25	3,46	3,68	3,90	4,11	4,33	4,55	4,76	4,98	5,20	5,20	5,20	5,20
3,25	5,86	3,15	3,38	3,61	3,83	4,06	4,28	4,51	4,73	4,96	5,18	5,41	5,63	5,86	5,86	5,86
3,50	6,55	3,51	3,74	3,98	4,21	4,44	4,68	4,91	5,14	5,38	5,61	5,85	6,08	6,31	6,55	6,55
3,75	7,26	3,87	4,12	4,36	4,60	4,84	5,08	5,33	5,57	5,81	6,05	6,29	6,54	6,78	7,02	7,26
4,00	8,00	4,25	4,50	4,75	5,00	5,25	5,50	5,75	6,00	6,25	6,50	6,75	7,00	7,25	7,50	7,75
4,25	8,76	4,64	4,90	5,15	5,41	5,67	5,93	6,18	6,44	6,70	6,96	7,22	7,47	7,73	7,99	8,25
4,50	9,55	5,04	5,30	5,57	5,83	6,10	6,36	6,63	6,89	7,16	7,42	7,69	7,95	8,22	8,49	8,75
4,75	10,35	5,45	5,72	5,99	6,27	6,54	6,81	7,08	7,36	7,63	7,90	8,17	8,45	8,72	8,99	9,26
5,00	11,18	5,87	6,15	6,43	6,71	6,99	7,27	7,55	7,83	8,11	8,39	8,66	8,94	9,22	9,50	9,78
5,25	12,03	6,30	6,59	6,87	7,16	7,45	7,73	8,02	8,31	8,59	8,88	9,17	9,45	9,74	10,02	10,31
5,50	12,90	6,74	7,04	7,33	7,62	7,92	8,21	8,50	8,79	9,09	9,38	9,67	9,97	10,26	10,55	10,85

- a) The anchor spacing and the edge distance shall not be smaller than the minimum anchor spacing  $s_{min}$  and the minimum edge distance  $c_{min}$ .

**Influence of embedment depth**

Anchor size	M8	M10	M12	M16	M20	M24
$f_{hef} = 0,05 \cdot (h_{ef} / d)^{1,68}$	0,75	0,67	0,61	0,55	0,62	0,67

**Influence of edge distance <sup>a)</sup>**

c/d	4	6	8	10	15	20	30	40
$f_c = (d / c)^{0,19}$	0,77	0,71	0,67	0,65	0,60	0,57	0,52	0,50

- a) The edge distance shall not be smaller than the minimum edge distance  $c_{min}$ .

**Combined tension and shear loading**

For combined tension and shear loading see section "Anchor Design".

**Precalculated values**

Design resistance calculated according ETAG 001, Annex C and data given in ETA-02/0042, issue 2008-01-10. All data applies to concrete C 20/25 –  $f_{ck,cube} = 25 \text{ N/mm}^2$ . HSL-3-SK and HSL-3-SH is only available up to M12.

Recommended loads can be calculated by dividing the design resistance by an overall partial safety factor for action  $\gamma = 1,4$ . The partial safety factors for action depend on the type of loading and shall be taken from national regulations.

## Design resistance

### Single anchor, no edge effects

Anchor size		Non-cracked concrete						Cracked concrete					
		M8	M10	M12	M16	M20	M24	M8	M10	M12	M16	M20	M24
Min. base material thickness $h_{min}$ [mm]		120	140	160	200	250	300	120	140	160	200	250	300
	<b>Tensile <math>N_{Rd}</math></b>												
	HSL-3, HSL-3-B, HSL-3-S, HSL-3-SH HSL-3-G [kN]	15,6	19,7	24,0	33,6	47,0	61,7	6,7	10,7	17,2	24,0	33,5	44,1
	<b>Shear <math>V_{Rd}</math>, without lever arm</b>												
	HSL-3, HSL-3-B, HSL-3-SK, HSL-3-SH [kN]	24,9	39,4	48,1	67,2	93,9	123,5	20,1	28,1	34,3	48,0	67,1	88,2
	HSL-3-G [kN]	20,9	27,8	43,4	67,2	93,9	-	20,1	27,8	34,3	48,0	67,1	-

### Single anchor, min. edge distance ( $c = c_{min}$ )

Anchor size		Non-cracked concrete						Cracked concrete					
		M8	M10	M12	M16	M20	M24	M8	M10	M12	M16	M20	M24
Min. base material thickness $h_{min}$ [mm]		120	140	160	200	250	300	120	140	160	200	250	300
Min. edge distance $c_{min}$ [mm]		60	70	80	100	125	150	60	70	80	100	125	150
	<b>Tensile <math>N_{Rd}</math></b>												
	HSL-3, HSL-3-B, HSL-3-SK, HSL-3-SH HSL-3-G [kN]	10,2	12,8	15,9	22,0	33,9	40,4	6,7	10,5	12,9	18,0	28,4	33,1
	<b>Shear <math>V_{Rd}</math>, without lever arm</b>												
	HSL-3, HSL-3-B, HSL-3-SK, HSL-3-SH [kN]	6,4	8,4	10,6	15,5	28,1	30,0	4,5	5,9	7,5	11,0	19,9	21,3
	HSL-3-G [kN]												

### Double anchor, no edge effects, min. spacing ( $s = s_{min}$ ), (load values are valid for one anchor)

Anchor size		Non-cracked concrete						Cracked concrete					
		M8	M10	M12	M16	M20	M24	M8	M10	M12	M16	M20	M24
Min. base material thickness $h_{min}$ [mm]		120	140	160	200	250	300	120	140	160	200	250	300
Min. spacing $s_{min}$ [mm]		60	70	80	100	125	150	60	70	80	100	125	150
	<b>Tensile <math>N_{Rd}</math></b>												
	HSL-3, HSL-3-B, HSL-3-SK, HSL-3-SH HSL-3-G [kN]	9,8	12,4	15,2	21,2	29,6	39,0	6,7	9,4	11,4	16,0	22,4	29,4
	<b>Shear <math>V_{Rd}</math>, without lever arm</b>												
	HSL-3, HSL-3-B, HSL-3-SK, HSL-3-SH [kN]	18,7	26,2	32,1	44,8	62,6	82,3	13,4	18,7	22,9	32,0	44,7	58,8
	HSL-3-G [kN]												