

ICC-ES Evaluation Report

ESR-2347

Reissued December 2023

This report also contains:

- LABC Supplement

Subject to renewal December 2024

- FBC Supplement

ICC-ES Evaluation Reports are not to be construed as representing aesthetics or any other attributes not specifically addressed, nor are they to be construed as an endorsement of the subject of the report or a recommendation for its use. There is no warranty by ICC Evaluation Service, LLC, express or implied, as to any finding or other matter in this report, or as to any product covered by the report.

Copyright © 2024 ICC Evaluation Service, LLC. All rights reserved.

<p>DIVISION: 05 00 00— METALS</p> <p>Section: 05 05 23— Metal Fastenings</p>	<p>REPORT HOLDER: HILTI, INC.</p>	<p>EVALUATION SUBJECT: HILTI LOW-VELOCITY POWER-ACTUATED DRIVEN THREADED STUDS FOR ATTACHMENT TO STEEL</p>	
--	---	--	---

1.0 EVALUATION SCOPE

Compliance with the following codes:

- 2021, 2018, 2015 and 2012 [International Building Code® \(IBC\)](#)
- 2021, 2018, 2015 and 2012 [International Residential Code® \(IRC\)](#)

For evaluation for compliance with codes adopted by [Los Angeles Department of Building and Safety \(LADBS\)](#), see [ESR-2347 LABC and LARC Supplement](#).

Property evaluated:

Structural

2.0 USES

The Hilti Low-velocity Power-Actuated Driven Threaded Studs are used as alternatives to the welds and bolts used to attach materials to structural steel, which are described in IBC Sections 2204.1 and 2204.2, respectively. The fasteners may be used for structures regulated under the IRC, when an engineered design is submitted in accordance with IRC Section R301.1.3.

3.0 DESCRIPTION

3.1 General:

Hilti low-velocity power-actuated threaded studs are fasteners with male threads for attachment of building materials on one end and a pointed- or blunt-tip shank on the other end for embedment into the supporting steel. The threaded studs are available with the thread designations, shank diameters, lengths and materials shown in [Table 1](#).

3.1.1 X-EW6H and X-EW10H Threaded Studs: These pointed-tip studs are formed from carbon steel, hardened in accordance with the manufacturer’s specifications, and zinc-plated in accordance with ASTM B633 SC 1, Type III. These studs are supplied with a plastic washer. See [Figure 1](#) for a depiction of the fasteners.

3.1.2 X-ST-GR M8 Threaded Studs: These pointed-tip studs consist of a threaded sleeve and a drive pin. The threaded sleeve is manufactured from SAE 316 stainless steel. These studs are supplied with plastic washers. The drive pin is manufactured from stainless steel conforming to specifications in the manufacturer’s quality documentation. See [Figure 2](#) for a depiction of the fastener.

3.1.3 X-BT Blunt-tip Threaded Studs:

3.1.3.1 X-BT M8, X-BT W10 and X-BT M10: These blunt-tip studs consist of a threaded sleeve and a drive pin, and may have a stainless steel/bonded elastomer sealing washer, designated SN12-R. The threaded sleeve and washer are manufactured from SAE 316 stainless steel. The drive pin is manufactured from a proprietary CrNiMo alloy complying with the requirements of SAE 316. See [Figure 3](#) for a depiction of the fasteners.

3.1.3.2 X-BT M6 and X-BT W6: These blunt-tip studs are formed as a single piece from a proprietary CrNiMo alloy complying with the requirements of SAE 316 stainless steel, and have a stainless steel/bonded elastomer sealing washer designated SN12-R. See [Figure 4](#) for a depiction of the fasteners.

3.1.4 X-BT-MR and X-BT-GR: These blunt-tip studs are formed as a single piece from a proprietary CrNiMo alloy complying with the requirements of SAE 316 stainless steel, and have a stainless steel/bonded elastomer sealing washer. The blunt tip is slightly tapered. See [Figures 5](#) and [6](#) for depictions of the fasteners.

3.2 Steel Substrates:

Structural steel must comply with the minimum requirements of ASTM A36, ASTM A572 Grade 50 or ASTM A992, and must have the minimum thicknesses, yield strength and tensile strength as shown in [Table 2, 3](#) and [4](#), as applicable.

4.0 DESIGN AND INSTALLATION

4.1 Design:

4.1.1 Allowable Loads: The most critical applied loads, excluding seismic load effects, resulting from the allowable stress design load combinations referenced in IBC Section 1605.1 or from the alternative allowable stress design load combinations in IBC Section 1605.2 (2018, 2015 and 2012 IBC Section 1605.3.1 or 1605.3.2) must not exceed the allowable loads given in this section. For fasteners which are subjected to seismic loads, see Section 4.1.3 for additional requirements. The allowable shear and tension loads for the threaded studs installed in steel are found in [Table 2, 3](#) and [4](#). The stress increases and load reductions described in 2021 IBC Section 1605.2 (2018, 2015 and 2012 IBC Section 1605.3) are not allowed. Allowable loads listed in [Table 2, 3](#) and [4](#) apply to the connection of the stud to the base material only. Other limit states applicable to the design of a connection, which are governed by the properties of the attached material, are outside the scope of this report. Design of the connection between the threaded stud and the attached material must comply with the applicable requirements of the IBC. When designing the connection of wood members to the base material, the bending yield strength of the threaded studs can be assumed to be the same as that of a nail with the same shank diameter as the stud.

4.1.2 Combined Loading: For fasteners subjected to both tension and shear loads, compliance with the following interaction equation must be verified:

$$(p/P_a) + (v/V_a) \leq 1.0$$

where:

p = Actual applied tension load on the fastener, lbf (N).

P_a = Allowable tension load for the fastener, lbf (N).

v = Actual applied shear load on the fastener, lbf (N).

V_a = Allowable shear load for the fastener, lbf (N).

4.1.3 Seismic Considerations: When the Hilti threaded studs (except for the X-ST-GR) are installed in steel and are subjected to seismic loads, the most critical load applied to each individual stud must be determined from the applicable allowable stress design load combinations referenced in IBC Section 1605.1 or from the alternative allowable stress design load combinations in IBC Section 1605.2 (2018, 2015 and 2012 IBC Section 1605.3.1 or Section 1605.3.2), and must not exceed the allowable seismic load shown in [Table 2, 3](#) or [4](#), including the footnotes, as applicable. Evaluation of the Hilti fasteners for use in the design of lateral force resisting systems, such as shear walls and diaphragms, is outside the scope of this report. The X-ST-GR fasteners may be used where the service load on any individual fastener does not exceed the lesser of 250 lbf (1112 N) or the published allowable load shown in [Table 2](#).

4.2 Installation:

4.2.1 General: The power-actuated threaded studs must be installed in accordance with this report and the Hilti, Inc. published installation instructions. A copy of these instructions must be available on the jobsite at all

times during installation. Installation is limited to dry, interior locations, except for stainless steel fasteners, which may be installed in exterior or damp environments.

Fastener placement requires the use of a Hilti low-velocity power-actuated tool (powder or electro-mechanically actuated) in accordance with Hilti, Inc. recommendations. Threaded studs must be installed with stud stand-off, h_{NVS} , dimensions as defined in [Figure 7](#) and [Table 1](#). Minimum spacing between fasteners must be 1 inch (25.4 mm) and minimum edge distance must be $\frac{1}{2}$ inch (12.7 mm). Installers must be certified by Hilti and have a current, Hilti-issued, operator's license. Installers of electro-mechanical-driven fasteners do not require an operator's license.

4.2.2 X-BT Blunt-tip Threaded Studs: The X-BT blunt-tip threaded studs require a pilot hole predrilled to the required depth with a Hilti TX-BT 4/7 step shank drill bit, in accordance with the manufacturer's published installation instructions. Installation instructions for the X-BT threaded studs are illustrated in [Figure 9](#).

4.2.3 X-BT-MR and X-BT-GR Blunt-tip Threaded Studs: The X-BT-MR and X-BT-GR blunt-tip threaded studs require a pilot hole predrilled to the required depth with a Hilti TX-BT 4.7/7 step shank drill bit, in accordance with the manufacturer's published installation instructions. Installation instructions for the X-BT-MR and X-BT-GR threaded studs are illustrated in [Figure 10](#).

4.2.4 Use with Treated Lumber: Hilti stainless steel threaded studs may be installed in contact with preservative-treated wood or fire-retardant-treated wood, as set forth in the applicable code. Carbon steel threaded studs may be used in contact with fire-retardant-treated wood in dry, interior locations only, in accordance with IBC Section 2304.10.6.4 (2018 and 2015 IBC Section 2304.10.5.4, 2012 IBC Section 2304.9.5.4) and Hilti's recommendations. Use of carbon steel threaded studs in contact with preservative-treated wood and with fire-retardant-treated wood in exterior applications is outside the scope of this report.

5.0 CONDITIONS OF USE:

The Hilti Low-Velocity Power-Actuated Driven Threaded Studs described in this report comply with, or are suitable alternatives to what is specified in, those codes listed in Section 1.0 of this report, subject to the following conditions:

- 5.1 The fasteners are manufactured and identified in accordance with this report.
- 5.2 Fastener installation complies with this report and the Hilti, Inc. published instructions. In the event of conflict between this report and the Hilti, Inc., published instructions, the more restrictive requirements govern.
- 5.3 Calculations demonstrating that the actual loads are less than the allowable loads described in this report must be submitted to the code official for approval. The calculations must be prepared by a registered design professional where required by the statutes of the jurisdiction in which the project is constructed.
- 5.4 Refer to Section 4.1.3 for seismic considerations.
- 5.5 Stainless steel threaded studs may be installed in exterior, damp environments. Qualification of glass-fiber-reinforced polyamide material is outside the scope of this report. Use of carbon steel threaded studs is limited to dry, interior locations, which include exterior walls which are protected by an exterior wall envelope.
- 5.6 Installation must comply with Section 4.2.4 regarding fasteners in contact with preservative-treated and fire-retardant-treated wood.
- 5.7 Installers must be certified by Hilti, Inc., and have a current, Hilti-issued, operator's license, except installers of electro-mechanical-driven fasteners do not require an operator's license.
- 5.8 The Hilti products addressed in this report are manufactured under a quality-control program with inspections by ICC-ES.

6.0 EVIDENCE SUBMITTED

Data in accordance with the [ICC-ES Acceptance Criteria for Power-Actuated Fasteners Driven into Concrete, Steel and Masonry Elements \(AC70\)](#), dated December 2019 (editorially revised January 2021), including seismic load test data in accordance with Annex A of AC70.

7.0 IDENTIFICATION

- 7.1 The ICC-ES mark of conformity, electronic labeling, or the evaluation report number (ICC-ES ESR-2347) along with the name, registered trademark, or registered logo of the report holder must be included in the product label.
- 7.2 In addition, each package of fasteners is labeled with the product designation. See [Figure 8](#) for head markings.

7.3 The report holder’s contact information is as follows:

HILTI, INC.
7250 DALLAS PARKWAY, SUITE 1000
PLANO, TEXAS 75024
(800) 879-8000
www.hilti.com

TABLE 1—THREADED STUD DESCRIPTIONS

PRODUCT DESIGNATION	THREAD DESIGNATION	SHANK DIAMETER in. (mm)	NOMINAL THREAD LENGTH in. (mm)	NOMINAL SHANK LENGTH in. (mm)	MATERIAL	THREADED STUD STAND-OFF, h_{NVS} ¹ in. (mm)
Pointed-Tip						
X-EW6H-11-9	UNC 1/4-inch	0.145 (3.7)	7/16 (11)	3/8 (9)	Carbon steel	3/8 – 1/2 (9.5-12.5)
X-EW6H-20-9	UNC 1/4-inch	0.145 (3.7)	3/4 (20)	3/8 (9)	Carbon steel	23/32 – 27/32 (18.5-21.5)
X-EW6H-28-9	UNC 1/4-inch	0.145 (3.7)	1 1/8 (28)	3/8 (9)	Carbon steel	1 1/16 – 1 5/32 (26.5-29.5)
X-EW6H-38-9	UNC 1/4-inch	0.145 (3.7)	1 1/2 (38)	3/8 (9)	Carbon steel	1 7/16 – 1 9/16 (36.5-39.5)
X-EW10H-30-14	UNC 3/8-inch	0.205 (5.2)	1 3/16 (30)	9/16 (14)	Carbon steel	1 3/32 – 1 7/32 (28.0-31.0)
X-ST-GR M8/5	Metric 8 mm	0.157 (4.0)	3/8 (9)	1/2 (12)	Stainless steel	15/32 – 19/32 (12.0–15.0)
X-ST-GR M8/10	Metric 8 mm	0.157 (4.0)	5/8 (15)	1/2 (12)	Stainless steel	21/32 – 25/32 (17.0–20.0)
Blunt-Tip						
X-BT W6-24-6 SN12-R	UNC 1/4-inch	0.177 (4.5)	15/16 (24)	1/4 (6)	Stainless steel	1 – 1 1/16 (25.7-26.8)
X-BT M6-24-6 SN12-R	Metric 6 mm	0.177 (4.5)	15/16 (24)	1/4 (6)	Stainless steel	1 – 1 1/16 (25.7-26.8)
X-BT M8-15-6-R ²	Metric 8 mm	0.177 (4.5)	5/8 (15)	1/4 (6)	Stainless steel	5/8 – 11/16 (15.7-16.8)
X-BT M8-15-6 SN12-R ²	Metric 8 mm	0.177 (4.5)	5/8 (15)	1/4 (6)	Stainless steel	5/8 – 11/16 (15.7-16.8)
X-BT W10-24-6-R ²	UNC 3/8-inch	0.177 (4.5)	15/16 (24)	1/4 (6)	Stainless steel	1 – 1 1/16 (25.7–26.8)
X-BT W10-24-6 SN12-R ²	UNC 3/8-inch	0.177 (4.5)	15/16 (24)	1/4 (6)	Stainless steel	1 – 1 1/16 (25.7–26.8)
X-BT M10-24-6-R ²	Metric 10 mm	0.177 (4.5)	15/16 (24)	1/4 (6)	Stainless steel	1 – 1 1/16 (25.7–26.8)
X-BT M10-24-6 SN12-R ²	Metric 10 mm	0.177 (4.5)	15/16 (24)	1/4 (6)	Stainless steel	1 – 1 1/16 (25.7–26.8)
X-BT-MR W6/10 SN 8 X-BT-MR W6/14 SN 8 ³	UNC 1/4-inch	Tapered	13/16 (20)	1/4 (6)	Stainless steel	1 – 1 1/16 (25.7-26.8)
X-BT-MR M6/10 SN 8 X-BT-MR M6/14 SN 8 ³	Metric 6 mm	Tapered	13/16 (20)	1/4 (6)	Stainless steel	1 – 1 1/16 (25.7-26.8)
X-BT-MR M8/14 SN 8	Metric 8 mm	Tapered	15/16 (24)	1/4 (6)	Stainless steel	1 – 1 1/16 (25.7-26.8)
X-BT-GR M8/7 SN 8	Metric 8 mm	Tapered	9/16 (14)	1/4 (6)	Stainless steel	5/8 – 11/16 (15.7-16.8)
X-BT-MR W10/15 SN 8	UNC 3/8-inch	Tapered	15/16 (24)	1/4 (6)	Stainless steel	1 – 1 1/16 (25.7-26.8)
X-BT-MR M10/15 SN 8	Metric 10 mm	Tapered	15/16 (24)	1/4 (6)	Stainless steel	1 – 1 1/16 (25.7-26.8)

For SI: 1 inch = 25.4 mm.

¹See Figure 7 for depiction of h_{NVS} .

²The suffix "Spec" may follow the M8, M10 and W10 designations, indicating the use of an alternate proprietary stainless steel specification.

³The maximum fixed component thickness of X-BT-MR W6/10 SN 8 and X-BT-MR M6/10 SN 8 is 10 mm, while the maximum fixed component thickness of X-BT-MR W6/14 SN 8 and X-BT-MR M6/14 SN 8 is 14 mm. The only difference between the /10 and /14 type studs is the thread length, which is shorter for the /10 type than the /14 type.

TABLE 2—ALLOWABLE LOADS FOR POINTED-TIP THREADED STUDS DRIVEN INTO ASTM A36 STEEL^{1,2,3} (lbf)

FASTENER	SHANK DIAMETER (in.)	STEEL THICKNESS (in.)									
		³ / ₁₆		¹ / ₄		³ / ₈		¹ / ₂		≥ ³ / ₄	
		Tension	Shear	Tension	Shear	Tension	Shear	Tension	Shear	Tension	Shear
X-EW6H	0.145	360	500	500	600	500	600	500	600	-	-
X-EW10H	0.205	-	-	970	1000	1100	1100	1100	1100	800	800
X-ST-GR M8 ⁴	0.157	-	-	405	405	405	405	405	405	-	-

For SI: 1 inch = 25.4 mm, 1 lbf = 4.4 N, 1 psi = 6895 Pa.

Notes:

¹Tabulated allowable load values based upon embedment in steel such that threaded stud stand-off, h_{NVS}, complies with [Table 1](#).

²All allowable load capacities above are based on base steel with minimum yield strength (F_y) of 36 ksi and a minimum tensile strength (F_u) of 58 ksi.

³Unless otherwise noted, allowable loads are applicable to static and seismic loads in accordance with Section 4.1.

⁴Tabulated loads for the X-ST-GR fastener apply to static load conditions only. For seismic loading, allowable load must be limited in accordance with Section 4.1.3.

TABLE 3—ALLOWABLE LOADS FOR BLUNT-TIP THREADED STUDS DRIVEN INTO ASTM A36 STEEL ≥ ⁵/₁₆ INCH THICK^{1,2,3,4}

FASTENER	SHANK DIAMETER (in.)	TENSION (lbf)	SHEAR (lbf)
X-BT M6, X-BT W6, X-BT M8, X-BT M10, or X-BT W10	0.177	405 ⁵	585 ⁶
X-BT-MR and X-BT-GR	Tapered	775 ⁵	820 ⁶

For SI: 1 inch = 25.4 mm, 1 lbf = 4.4 N, 1 psi = 6895 Pa.

Notes:

¹Tabulated allowable load values based upon embedment in steel such that threaded stud stand-off, h_{NVS}, complies with [Table 1](#).

²All allowable load capacities above apply to base steel with minimum yield strength (F_y) of 36 ksi and a minimum tensile strength (F_u) of 58 ksi.

³Installation of X-BT fasteners must be in accordance with Section 4.2.2 and [Figure 9](#) of this report.

⁴Installation of X-BT-MR and X-BT-GR fasteners must be in accordance with Section 4.2.3 and [Figure 10](#) of this report.

⁵Tabulated allowable tension load is applicable to static and seismic loads in accordance with Section 4.1.

⁶Tabulated allowable shear load is applicable to static and seismic loads in accordance with Section 4.1 and the following: For seismic loads for the X-BT M6 and X-BT W6 fasteners, multiply the tabulated shear load by 0.915; for seismic loads for the X-BT M8, X-BT M10 and X-BT W10 fasteners multiply the tabulated shear load by 0.983. For the X-BT-MR and X-BT-GR fasteners multiply the tabulated shear load by 0.665.

TABLE 4—ALLOWABLE LOADS FOR BLUNT-TIP THREADED STUDS DRIVEN INTO ASTM A572 STEEL ≥ ⁵/₁₆ INCH THICK^{1,2,3}

FASTENER	SHANK DIAMETER (in.)	TENSION (lbf)	SHEAR (lbf)
X-BT-MR and X-BT-GR	Tapered	840 ⁴	885 ⁵

For SI: 1 inch = 25.4 mm, 1 lbf = 4.4 N, 1 psi = 6895 Pa.

Notes:

¹Tabulated allowable load values based upon embedment in steel such that threaded stud stand-off, h_{NVS}, complies with [Table 1](#).

²All allowable load capacities above apply to base steel with minimum yield strength (F_y) of 50 ksi and a minimum tensile strength (F_u) of 65 ksi.

³Installation of X-BT-MR and X-BT-GR fasteners must be in accordance with Section 4.2.3 and [Figure 10](#) of this report.

⁴Tabulated allowable tension load is applicable to static and seismic loads in accordance with Section 4.1.

⁵Tabulated allowable shear load is applicable to static and seismic loads in accordance with Section 4.1 and the following: For seismic loads, multiply the tabulated shear load by 0.667.

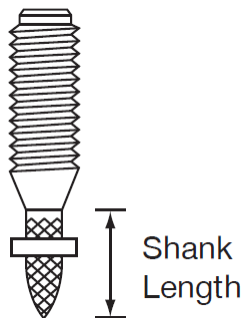

FIGURE 1—HILTI X-EW6H AND X-EW10H THREADED STUDS



FIGURE 2—HILTI X-ST-GR M8 THREADED STUD

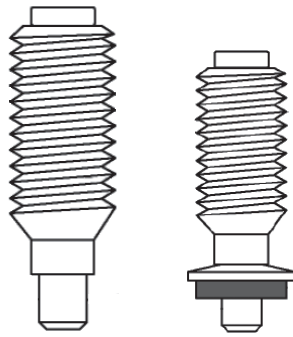

FIGURE 3—HILTI X-BT BLUNT-TIP THREADED STUD WITH AND WITHOUT SN12-R SEALING WASHER

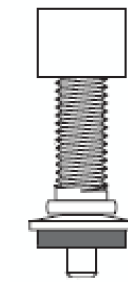

FIGURE 4—HILTI X-BT M6 AND W6 THREADED STUDS WITH SN12-R SEALING WASHER



FIGURE 5—HILTI X-BT-MR M6 AND X-BT-MR W6 BLUNT-TIP THREADED STUDS

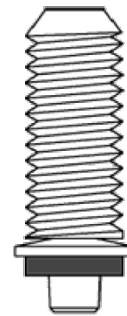

FIGURE 6—HILTI X-BT-MR M8, X-BT-MR M10, X-BT-MR W10, AND X-BT-GR M8 BLUNT-TIP THREADED STUDS

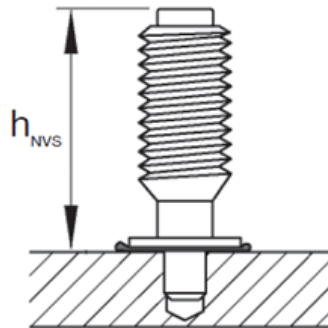
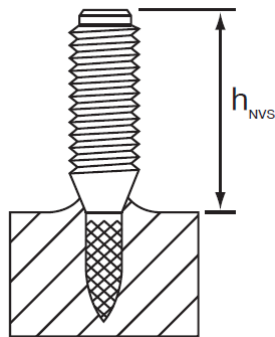

FIGURE 7—DEPICTION OF THREADED STUD STAND-OFF, h_{NVS} , FOR POINTED-TIP AND BLUNT-TIP THREADED STUDS



Carbon steel studs



Stainless steel pointed tip studs and X-BT, X-BT-MR M8/W10/M10 and X-BT-GR M8 blunt-tip studs



X-BT-MR M6 and X-BT-MR W6 blunt-tip studs

FIGURE 8—DEPICTION OF IDENTIFYING HEAD MARKINGS FOUND ON TOP OF THREADED STUDS

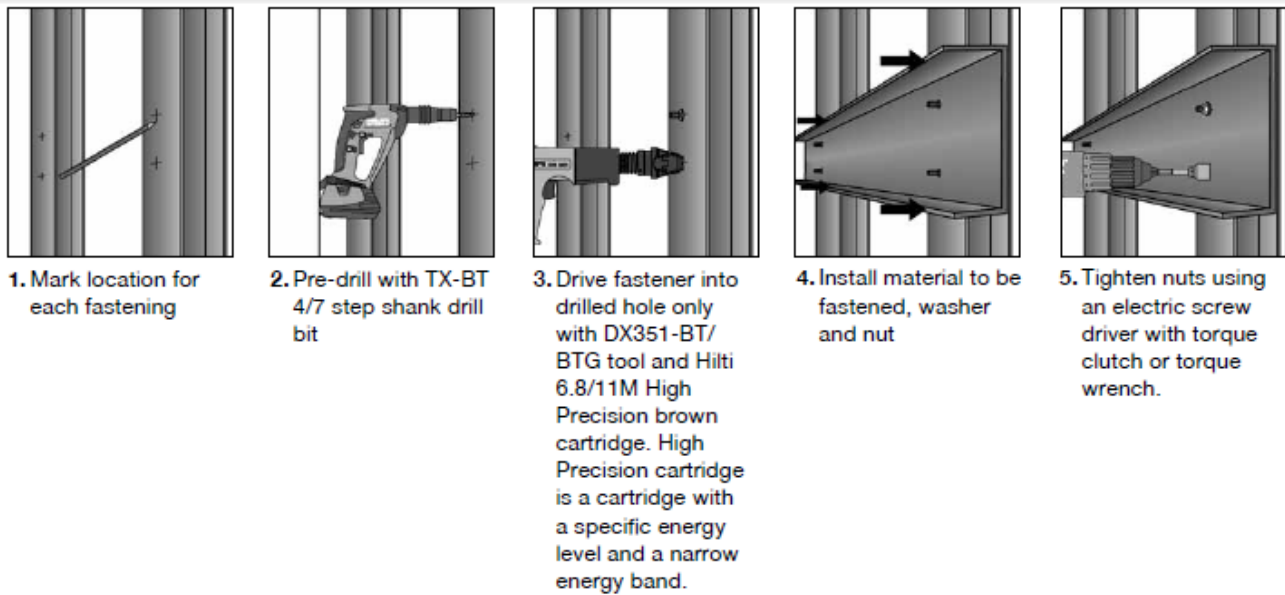

Installation Details

Pre-drill until shoulder grinds a shiny ring (to assure proper drilling depth).

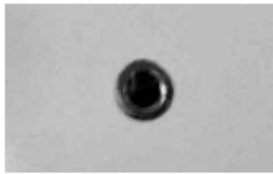

Before fastener installation:
The drilled hole must be clear of liquids and debris. Area around drilled hole must be free from liquids and debris.

2 NO debris NO water, oil, etc.

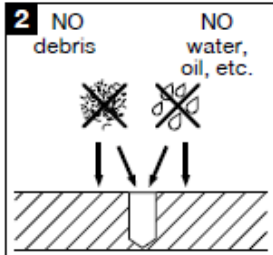

Adjust power on the **DX351-BT/BTG** so that the fastener stand-off, h_{NVS} , is:

Fastener	h_{NVS}
X-BT W6 and W10	1.012"–1.055" (25.7–26.8 mm)
X-BT M8	0.618"–0.661" (15.7–16.8 mm)



Proper compression of the sealing washer must be achieved.



Power regulation guide to check fastener stand-off available from Hilti.

Tightening torque, $T_{max} = 6 \text{ ft-lb (8 Nm)}$

Hilti Tool	Torque Setting ¹
SFH 18-A	9-10
SF 18-A	9-10
SFH 144-A	9-10
SF 144-A	9-10

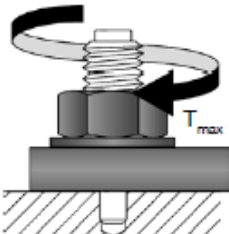

¹ Tool torque settings are for guideline purposes. Tool wear and temperature as well as battery charge will influence torque characteristics.

FIGURE 9—INSTALLATION INSTRUCTIONS FOR HILTI X-BT THREADED STUDS
Note: These are typical installation procedures shown for general understanding of the product. Specific installation procedures in the manufacturer’s published installation instructions included with the product, must be followed.

Fastening Tool: DX 351

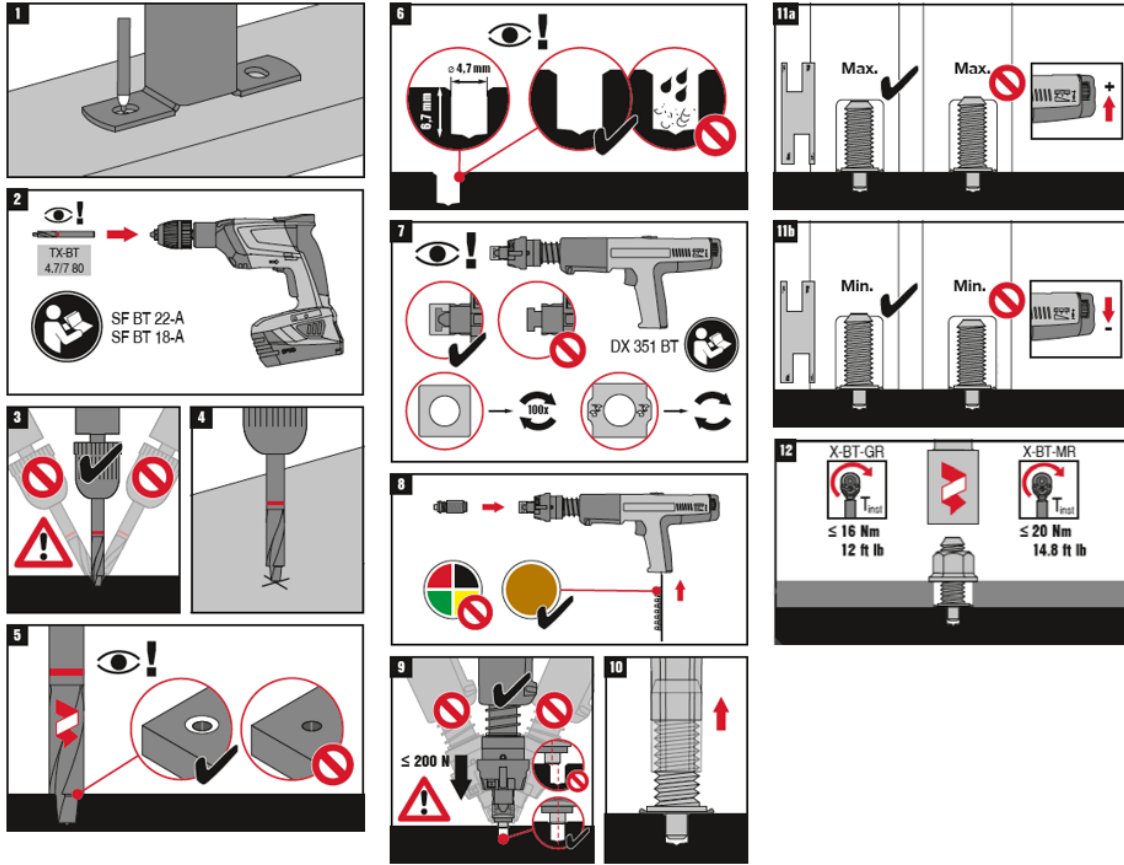

Fastening Tool: BX 3

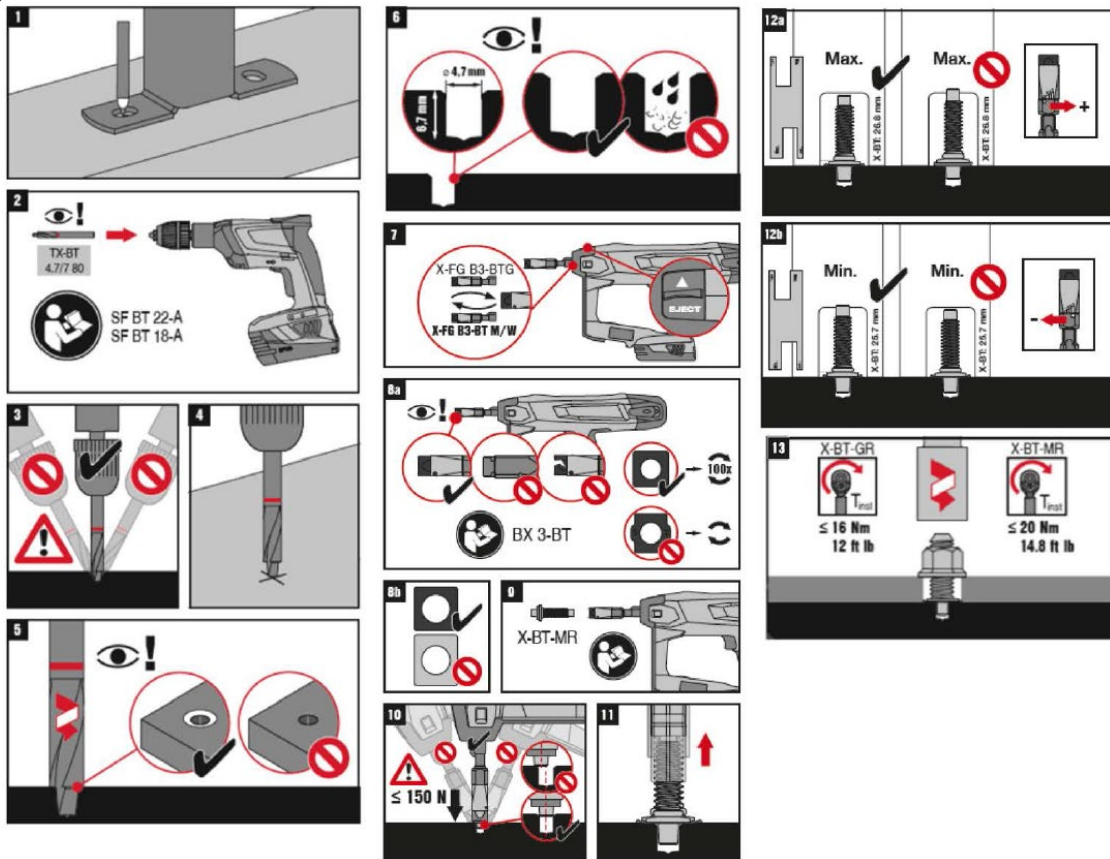

FIGURE 10—INSTALLATION INSTRUCTIONS FOR HILTI X-BT-MR AND X-BT-GR THREADED STUDS
 Note: These are typical installation procedures shown for general understanding of the product. Specific installation procedures in the manufacturer’s published installation instructions included with the product, must be followed.

DIVISION: 05 00 00—METALS**Section: 05 05 23—Metal Fastenings****REPORT HOLDER:**

HILTI, INC.

EVALUATION SUBJECT:

HILTI LOW-VELOCITY POWER-ACTUATED DRIVEN THREADED STUDS FOR ATTACHMENT TO STEEL

1.0 REPORT PURPOSE AND SCOPE**Purpose:**

The purpose of this evaluation report supplement is to indicate that the Hilti Low-Velocity Power-Actuated Driven Threaded Studs for Attachment to Steel, described in ICC-ES evaluation report [ESR-2347](#), have also been evaluated for compliance with the codes noted below as adopted by the Los Angeles Department of Building and Safety (LADBS).

Applicable code editions:

- 2023 *City of Los Angeles Building Code* (LABC)
- 2023 *City of Los Angeles Residential Code* (LARC)

2.0 CONCLUSIONS

The Hilti Low-Velocity Power-Actuated Driven Threaded Studs for Attachment to Steel, described in Sections 2.0 through 7.0 of the report [ESR-2347](#), comply with the LABC Chapter 22, and the LARC, and are subject to the conditions of use described in this supplement.

3.0 CONDITIONS OF USE

The Hilti Low-Velocity Power-Actuated Driven Threaded Studs for Attachment to Steel described in this evaluation report supplement must comply with all of the following conditions:

- All applicable sections in the evaluation report [ESR-2347](#).
- The design, installation, conditions of use and identification of the Hilti Low-Velocity Power-Actuated Driven Threaded Studs for Attachment to Steel are in accordance with the 2021 *International Building Code*® (IBC) provisions noted in the evaluation report [ESR-2347](#).
- The design, installation and inspection are in accordance with additional requirements of LABC Chapters 16 and 17, as applicable.
- For seismic applications, Hilti Low-Velocity Power-Actuated Driven Threaded Studs for Attachment to Steel must comply with Section 4.1.3 of the evaluation report [ESR-2347](#).
- Under the LARC, an engineered design in accordance with LARC Section R301.1.3 must be submitted.
- The allowable load values listed in the evaluation report are for the connection of the threaded studs to steel. The connection between the threaded studs and the connected building materials must be checked for capacity (which may govern).

This supplement expires concurrently with the evaluation report, reissued December 2023.

DIVISION: 05 00 00—METALS

Section: 05 05 23—Metal Fastenings

REPORT HOLDER:

HILTI, INC.

EVALUATION SUBJECT:

HILTI LOW-VELOCITY POWER-ACTUATED DRIVEN THREADED STUDS FOR ATTACHMENT TO STEEL

1.0 REPORT PURPOSE AND SCOPE

Purpose:

The purpose of this evaluation report supplement is to indicate that the Hilti Low-Velocity Power-Actuated Driven Threaded Studs for Attachment to Steel, described in ICC-ES evaluation report ESR-2347, have also been evaluated for compliance with the codes noted below.

Applicable code editions:

- 2023 Florida Building Code—Building
- 2023 Florida Building Code—Residential

2.0 CONCLUSIONS

The Hilti Low-Velocity Power-Actuated Driven Threaded Studs for Attachment to Steel, described in Sections 2.0 through 7.0 of the evaluation report ESR-2347, comply with the *Florida Building Code—Building* and the *Florida Building Code—Residential*. The design requirements must be determined in accordance with the *Florida Building Code—Building* or the *Florida Building Code—Residential*, as applicable. The installation requirements noted in ICC-ES evaluation report ESR-2347 for the 2021 *International Building Code*® meet the requirements of the *Florida Building Code—Building* or the *Florida Building Code—Residential*, as applicable.

Use of the Hilti Low-Velocity Power-Actuated Driven Threaded Studs for Attachment to Steel has also been found to be in compliance with the High-Velocity Hurricane Zone provisions of the *Florida Building Code—Building* and the *Florida Building Code—Residential*.

For products falling under Florida Rule 61G20-3, verification that the report holder's quality-assurance program is audited by a quality-assurance entity approved by the Florida Building Commission for the type of inspections being conducted is the responsibility of an approved validation entity (or the code official, when the report holder does not possess an approval by the Commission).

This supplement expires concurrently with the evaluation report, reissued December 2023.